

# KOMATSU®

## PC600/600LC-8E0 BACKHOE PC600/600LC-8E0 LOADING SHOVEL

ecot3

### HORSEPOWER

Gross:323 kW 433 HP @ 1800 rpm

Net:320 kW 429 HP @ 1800 rpm

### OPERATING WEIGHT

Backhoe:59200-61900 kg

130,510-136,460 lb

Loading shovel:63200-64200 kg

139,330-141,540 lb

PC  
600



Photo may include optional equipment.

HYDRAULIC EXCAVATOR

# WALK-AROUND

## Productivity Features

- **High Work Equipment Speed**  
Increased arm dumping speed and arm speed of compound operation by arm regeneration circuit realize efficient loading operation.
- **Lifting Mode**  
The lifting mode increases the lifting force by 17%.
- **Large Digging Force**  
Pressing the Power Max function button temporarily increases the digging force 8%.
- **Two-mode Setting for Boom**  
Switch selection allows either powerful digging or smooth boom operation.
- **Large Drawbar Pull and Steering Force**  
provide excellent mobility.

See page 5.

## Excellent Reliability and Durability

- **Strengthened Boom and Arm**
- **KMAX Bucket** offers superior wear-resistance for specific use in quarry.
- **Fuel Pre-filter** with water separator equipped and **High Efficiency Fuel Filter** as standard
- **O-ring Face Seals**, which have excellent sealing performance, are used for the hydraulic hoses.
- **High-pressure In-line Filtration**  
The cool-running hydraulic system is protected with the most extensive filtration system available, including a high pressure in-line filter for each main pump.
- **Highly Reliable Electronic Devices**  
Exclusively designed electronic devices have passed severe testing.
  - Controller • Sensors • Connectors
  - Heat resistant wiring

See pages 6, 7.



## Maintenance Features

- **Easy Cleaning of Cooling unit**  
Fan reverse-rotation function facilitates clogged radiator cleaning.
- **Easy Detachable Radiator and Oil Cooler**
- **Easy Checking and Maintenance of Engine**
- **Work on Machine Anti-slip Plates for Safe**
- **Large Handrail, Step and Catwalk**  
provide easy access to the engine and hydraulic equipment.

See page 11.

## Ecology and Economy Features

### • Low Emission Engine

A powerful, turbocharged and air-to-air aftercooled Komatsu SAA6D140E-5 provides **320 kW** 429 HP. This engine is EPA Tier 3 and EU Stage 3A emissions certified, without sacrificing power or machine productivity.

### • Economy mode Four-level Setting

Enables operator to select the appropriate Economy mode level to match production requirement with lowest fuel consumption.

### • Reduction of Ambient Noise

- Electronically controlled variable speed fan drive
- Large hybrid fan
- Glasswool-furnished low-noise muffler and noise reducing cover around the muffler

### • Mode Selection

- Economy mode improves fuel consumption.
- Eco-gauge for energy-saving operations
- Extended idling caution for fuel conservation
- Auto deceleration and auto idling system reduce fuel consumption.

See pages 4, 5.



Photo may include optional equipment.

## Working Environment

### • Large Comfortable Cab

- Low-noise cab
- Low vibration with cab damper mounting
- Highly pressurized cab with optional air conditioner
- Operator seat and console with armrest that enables operations in the appropriate operational posture.
- OPG top guard level 2 (by ISO 10262 standard) capable with optional bolt-on top guard

See pages 8, 9.

### Large TFT LCD Monitor

- Easy-to-see and use 7" large multi-function color monitor
- Can be displayed in 12 languages for global support.

TFT : Thin Film Transistor  
LCD : Liquid Crystal Display

See page 10.

**HORSEPOWER**  
Gross:323 kW 433 HP @ 1800 rpm  
Net:320 kW 429 HP @ 1800 rpm

### OPERATING WEIGHT

#### Backhoe

**59200 – 61900 kg**  
130,510 – 136,460 lb

#### Loading shovel

**63200 – 64200 kg**  
139,330 – 141,540 lb

# PRODUCTIVITY & ECOLOGY FEATURES

## Komatsu Technology



Komatsu develops and produces all major components, such as engines, electronics and hydraulic components, in house. With this "Komatsu Technology," and adding customer feedback, Komatsu is achieving great advancements in technology. To achieve both high levels of productivity and economical performance, Komatsu has developed the main components with a total control system. The result is a new generation of high performance and environment friendly excavators.

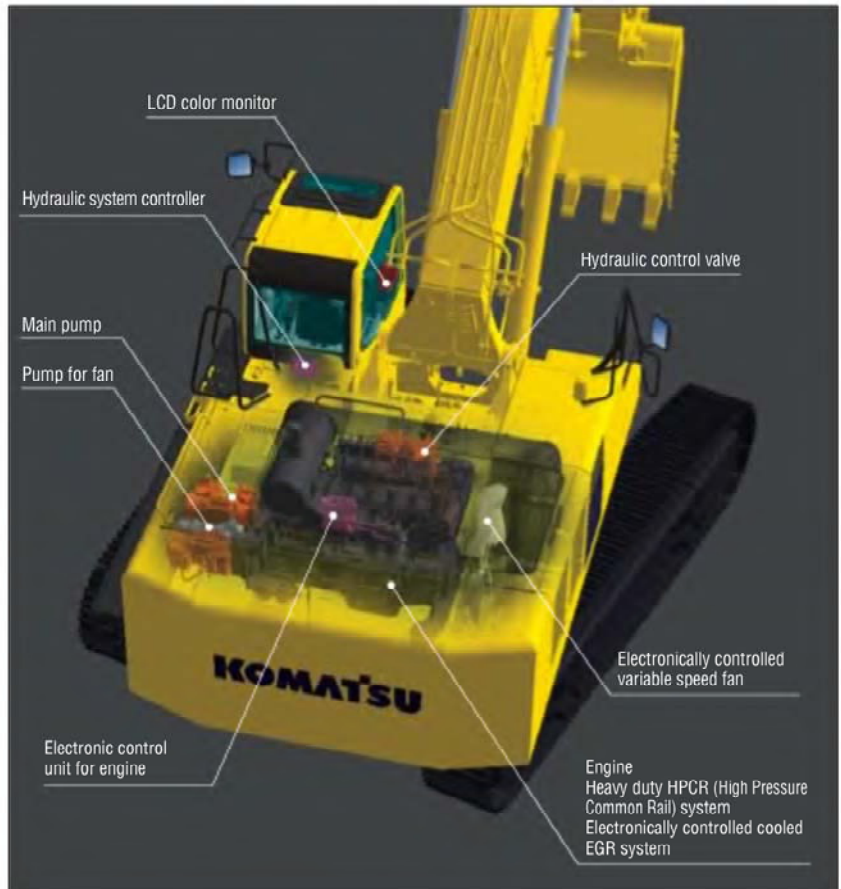

### Low Emission Engine

Komatsu SAA6D140E-5 engine is EPA Tier 3 and EU Stage 3A emissions certified, without sacrificing power or machine productivity.



### Electronically Controlled Variable Speed Fan Contributes to Low Fuel Consumption and Low Noise

The electronic control system sets the revolution speed of the cooling fan according to the coolant, hydraulic oil, and ambient temperature; effectively uses the engine output to prevent wasteful fuel consumption; and reduces noise during low-speed fan revolution.

### Lower and Economical Fuel Consumption Using Economy Mode

Enables operator to set the Economy mode to four levels according to working conditions so that production requirement is achieved at lowest fuel consumption.



### Low Ambient Noise

Reduced noise by adoption of an electronically controlled variable speed fan drive, large hybrid fan and low-noise muffler.

### Eco-gauge that Assists Energy-saving Operations

Eco-gauge is equipped for environment friendly energy-saving operations. Focus on operation in the green range allows reduction of CO<sub>2</sub> emission and fuel consumption.



Eco-gauge

### Idling Caution

To prevent unnecessary fuel consumption, an idling caution is displayed on the monitor, if the engine idles for 5 minutes or more.



### Auto Deceleration and Auto Idling System

Auto deceleration system is equipped to reduce fuel consumption and operating noise. Also, engine idling speed can be set at a lower speed on monitor with auto idling system.

### Working Modes Selectable

P and E modes established work modes are further improved.

**P mode** – Power or work priority mode has low fuel consumption, but fast equipment speed and maximum production and power are maintained.

**E mode** – Economy or fuel saving mode further reduces fuel consumption, but maintains the P-mode-like working equipment speed for light duty work.



You can select Power or Economy modes using a one-touch operation on the monitor panel depending on workloads.

### Lifting Mode

Gives 17% more lifting force when needed for handling rock or heavy lifting applications.

### Large Drawbar Pull and Steering Force

Since the machine has a large drawbar pull and a high steering force, it demonstrates excellent mobility even when it is on inclined sites.

### Large Digging Force

With the addition of one-touch Power Max. function digging force is further increased. (8 seconds of operation)

#### Maximum arm crowd force (ISO):

228 kN (23.3 tonf) → **246 kN (25.1 tonf)** **8% UP**  
(with Power Max.)

#### Maximum bucket digging force (ISO):

294 kN (30.0 tonf) → **317 kN (32.3 tonf)** **8% UP**  
(with Power Max.)

\*Measured with Power Max function, 3500 mm 11'6" arm and ISO rating

### Work Equipment Speed Increased

Work equipment speed and arm speed of compound operation becomes greater with arm quick return circuit and arm regeneration circuit. Quick loading work is now accomplished.

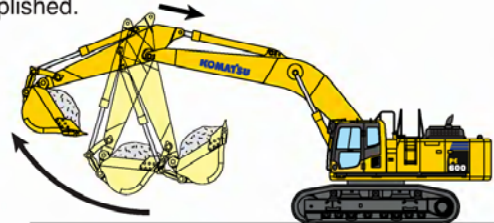

### Two-mode Setting for Boom

**Smooth mode** provides easy operation for gathering blasted rock and scraping operations. When maximum digging force is needed, switch to **power mode** for more effective excavating.

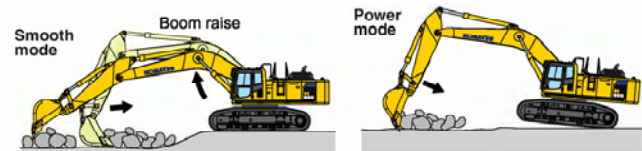
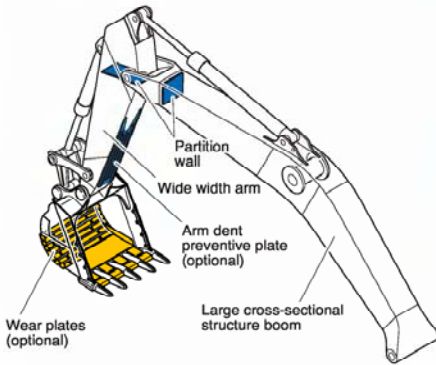

Photo may include optional equipment.

# RELIABILITY FEATURES

## Strengthened Boom and Arm (optional)

Thanks to the large cross-sectional structure employing a high tensile strength steel with a thick plate, partition wall, etc., the boom and arm exhibit excellent durability and are highly resistant to bending and torsional stress.



## O-ring Face Seal

The hydraulic hose seal method has been changed from a conventional taper seal to an O-ring seal. This provides improved sealing performance during operation.

## Frame Structure

The revolving frame mount and center frame mount on the swing circle are no welding structure so that force is transmitted directly to the thick plate of the frame without passing through any welding.

## Fuel Pre-filter (with Water Separator)

Removes water and contaminants from fuel to enhance the fuel system reliability.



## High Efficiency Fuel Filter

Fuel system reliability is even better with high efficiency fuel filter.

## High-pressure In-line Filtration

The PC600-8E0 has the most extensive filtration system available, providing in-line filters as standard equipment. An in-line filter in the outlet port of each main hydraulic pump reduces failures caused by contamination.

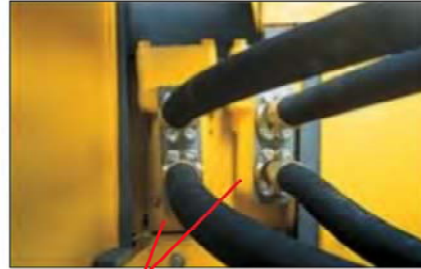

In-line filter

## Metal Guard Rings

Metal guard rings protect all the hydraulic cylinders and improve reliability.

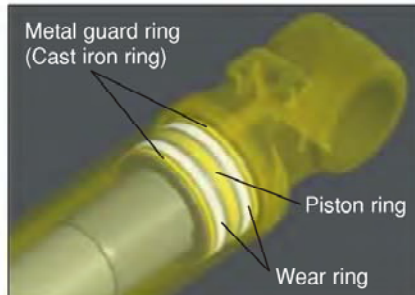

## Heat-resistant Wiring

Heat-resistant wiring is used for the engine electric circuit and other major component circuit.

## Circuit Breaker

With circuit breaker, the machine can be easily restarted after repair.



## Sturdy Undercarriage

The undercarriage is strengthened to provide excellent reliability and durability when working on rocky ground or blasted rock.

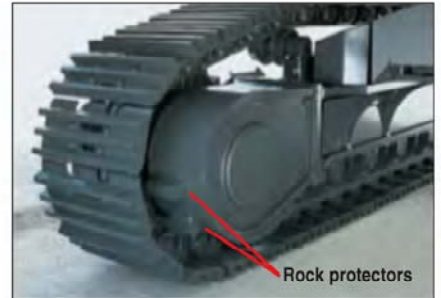

Sturdy guards shield the travel motors and pipings against damage from rocks. (Rock protectors are optional.)

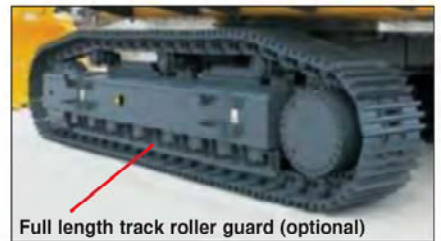

## Strengthened Revolving Frame Underguard

Guards the machine pipings against being hit by rocks from below and prevents hydraulic components and the engine from being damaged.

## DT-type connectors

DT-type connectors seal tight and have higher reliability.



**Strengthened Quarry Bucket Provides Outstanding Wear-resistance (optional)**

The bucket for specific use in quarry is impact and wear resistant, providing high performance and long life.

Koma-hard materials\* provide excellent wear resistance. Combined with adoption of long-life KMAX tooth, durability of bucket is drastically enhanced.

\* Koma-hard materials (KVV materials):  
 Komatsu developed, wear-resistant, reinforced materials.  
 Brinell hardness: 500 or more (180kgf/mm<sup>2</sup> class).  
 Features high wear-resistance and little quality change by the heat generated during rock loading, maintaining the hardness for a long term.

**KMAX Tooth for Quarry Bucket**

- Unique bucket tooth shape superior digging performance
- Long-term high sharpness
- Great penetration performance
- Hammerless, safe, and easy tooth replacement  
 (Tooth replacement time: Halves the conventional machine.)

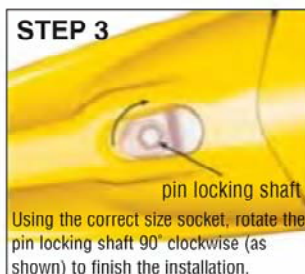
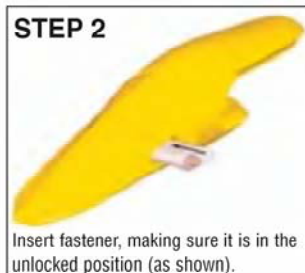
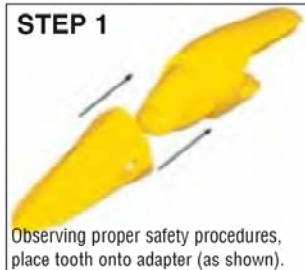
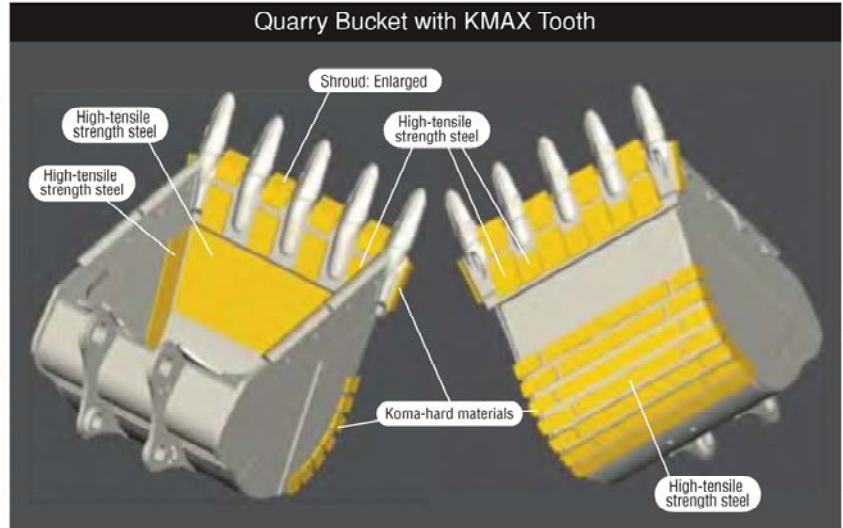

Photo may include optional equipment.

# WORKING ENVIRONMENT



Photo may include optional equipment.

## Low Noise Design Cab

The newly-designed cab is highly rigid and has excellent sound absorption ability. Thorough improvement of noise source reduction and use of low noise engine, hydraulic equipment, and air conditioner allows the operator to work in quiet condition.

## Wide Newly-designed Cab

Newly-designed wide spacious cab includes seat with reclining backrest. The seat height and longitudinal inclination are easily adjusted using a pull-up lever. You can set the appropriate operational posture of armrest together with the console. Reclining the seat further enables you to place it into the fully flat state with the headrest attached.



Seat with headrest reclined full flat

## Pressurized Cab

Optional air conditioner, air filter and a higher internal air pressure (+6.0 mm Aq +0.2"Aq) prevent external dust from entering the cab.



**Multi-position Controls**

The multi-position, PPC (proportional pressure control) levers allow the operator to work in comfort while maintaining precise control. A double-slide mechanism allows the seat and control levers to move together or independently, allowing the operator to position the controls for maximum productivity and comfort.



Seat sliding amount: 340 mm 13.4"

**Low Vibration with Cab Damper Mounting**

PC600-8E0 uses viscous damper mounting for cab that incorporates longer stroke and the addition of a spring. The cab damper mounting combined with high rigidity deck aids vibration reduction at operator seat.

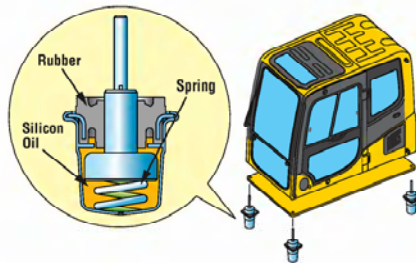

**Cab Equipments**



Skylight



Sliding Window and Large Side Mirror



Defroster (optional)

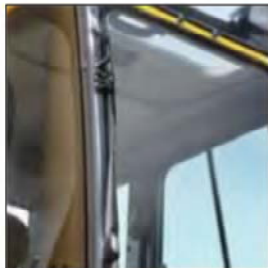

Cab Frame Mounted Wiper

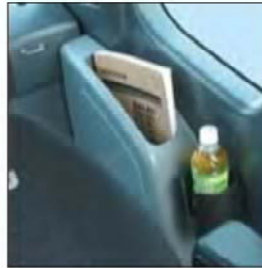

Bottle Holder and Magazine Rack

**Automatic Air Conditioner (optional)**

Enables you to easily and precisely set cab atmosphere with the instruments on the large LCD.



The bi-level control function keeps the operator's head and feet cool and warm respectively. This improved air flow function keeps the inside of the cab comfortable throughout the year. Defroster function keeps front glass clear.

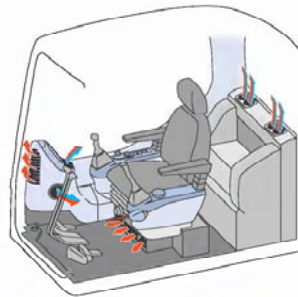

**Safety Features**

**Step Light with Timer (optional)**

provides light for about one minute to allow the operator to get off the machine safely.

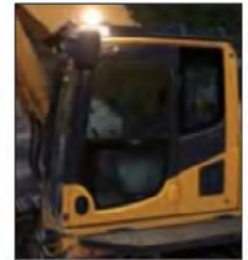

**Pump/engine Room Partition**

prevents oil from spraying on the engine if a hydraulic hose should burst.

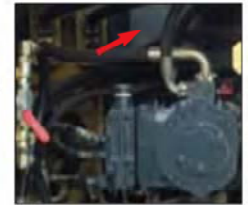

**Thermal and Fan Guards**

are placed around high-temperature parts of the engine and fan drive.

**Anti-slip Plates**

Spiked plates on working areas provide anti-slip performance.

**Horn Interconnected with Warning Light (optional)**

gives visual and audible notice of the excavator's operation when activated.



**Rear View Monitoring System (optional)**

The operator can view the rear of the machine with a color monitor screen.



**OPG top guard (optional)**

OPG top guard Level 2 (by ISO 10262) capable with optional bolt-on top guard.

## Large LCD Color Monitor

### Large Multi-lingual LCD Monitor

A large user-friendly color monitor enables safe, accurate and smooth work. Improved screen visibility is achieved by the use of TFT liquid crystal display that can easily be read at various angles and lighting conditions. Simple and easy to operate switches. Function keys facilitate multi-function operations. Displays data in 12 languages to support operators around the world.



#### Indicators

- |                                  |                                   |
|----------------------------------|-----------------------------------|
| 1 Auto-decelerator               | 5 Hydraulic oil temperature gauge |
| 2 Working mode                   | 6 Fuel gauge                      |
| 3 Travel speed                   | 7 Eco-gauge                       |
| 4 Engine water temperature gauge | 8 Function switches menu          |

#### Basic operation switches

- |                                    |                     |
|------------------------------------|---------------------|
| 1 Auto-decelerator (& auto idling) | 4 Buzzer cancel     |
| 2 Working mode selector            | 5 Wiper             |
| 3 Traveling selector               | 6 Windshield washer |

### Mode Selection

The multi-function color monitor has Power mode (two levels), Economy mode (four levels), and Lifting mode.

Working Mode	Application	Advantage
<b>P</b> (P0,P1)	Power Mode	<ul style="list-style-type: none"> <li>Maximum production/power</li> <li>Fast cycle time</li> </ul>
<b>E</b> (E0,E1,E2,E3)	Economy Mode	<ul style="list-style-type: none"> <li>Good cycle time</li> <li>Good fuel economy</li> </ul>
<b>L</b>	Lifting Mode	<ul style="list-style-type: none"> <li>Hydraulic pressure is increased 17%.</li> </ul>

### EMMS

#### (Equipment Management Monitoring System)

##### Monitor Function

Controller monitors engine oil level, coolant temperature, battery charge and air clogging, etc. If controller finds any abnormality, it is displayed on the LCD.



##### Maintenance Function

Monitor informs replacement time of oil and filters on LCD when the replacement interval is reached.

##### Trouble Data Memory Function

Monitor stores abnormalities for effective troubleshooting.



# MAINTENANCE FEATURES

## Easy Checking and Maintenance of Engine

Engine check points are concentrated on one side of the machine to facilitate daily checks. Thermal guards are placed around high-temperature parts such as turbocharger.



## Wide Catwalk

Easier, safer operator cab access and maintenance checks.



## Steps Connected to the Machine Cab

Steps allows access from left hand catwalk to top of machine for engine check and maintenance.



## Anti-slip Plates

Spiked plates provided on top of the machine cab maintains anti-slip performance for a prolonged period.

## Easy Cleaning of Cooling Unit

Reverse-rotation function of the hydraulic driven fan facilitates cleaning of the cooling unit.



## Easy Detachable Radiator and Oil Cooler

Engine hood opens fully to facilitate removal and installation of the radiator and oil cooler. The hood can be opened vertically by changing the position of the torsion bar.



## Long-life Oil, Filter

Uses high-performance filtering materials and long-life oil. Extends the oil and filter replacement interval.



Hydraulic oil filter (Eco-white element)

Engine oil & Engine oil filter	every 500 hours
Hydraulic oil	every 5000 hours
Hydraulic oil filter	every 1000 hours

## Electric Pump, Grease Gun with Indicator (optional)

Greasing is made easy with the electric pump, grease gun with indicator.



Indicator Grease gun



Photo may include optional equipment.





## DIMENSIONS

	Boom	7660 mm 25'2"	7660 mm 25'2"	7660 mm 25'2"	7300 mm 23'11"	6600 mm 21'8"
	Arm	3500 mm 11'6"	4300 mm 14'1"	5200 mm 17'1"	3500 mm 11'6"	2900 mm 9'6"
A	Overall length	12960 mm 42'6"	12880 mm 42'3"	12585 mm 41'3"	12590 mm 41'4"	11980 mm 39'4"
B	Overall height (to top of boom)	4300 mm 14'1"	4655 mm 15'3"	5235 mm 17'2"	4280 mm 14'1"	4600 mm 15'1"

		PC600-8E0	PC600LC-8E0
C	Overall width	4210 mm 13'10"	4210 mm 13'10"
D	Overall height (to top of cab)	3290 mm 10'10"	3290 mm 10'10"
E	Ground clearance, counterweight	1365 mm 4'6"	1365 mm 4'6"
F	Ground clearance (minimum)	780 mm 2'7"	780 mm 2'7"
G	Tail swing radius	3950 mm 13'0"	3950 mm 13'0"
H	Track length on ground	4250 mm 13'11"	4600 mm 15'1"
I	Track length	5340 mm 17'6"	5690 mm 18'8"
J	Track gauge	2590 mm 8'6"	2590 mm 8'6"
K	Track gauge when expanded	3300 mm 10'10"	3300 mm 10'10"
L	Width of crawler	3190 mm 10'6"	3190 mm 10'6"
M	Width of crawler when expanded	3900 mm 12'10"	3900 mm 12'10"
N	Shoe width	600 mm 24"	600 mm 24"
O	Grouser height	37 mm 1.5"	37 mm 1.5"
P	Machine cab height	3435 mm 11'3"	3435 mm 11'3"
Q	Machine cab width	3170 mm 10'5"	3170 mm 10'5"
R	Distance, swing center to rear end	3825 mm 12'7"	3825 mm 12'7"

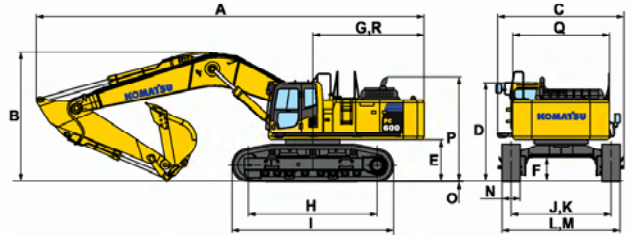

## WORKING RANGE

Unit: mm ft in

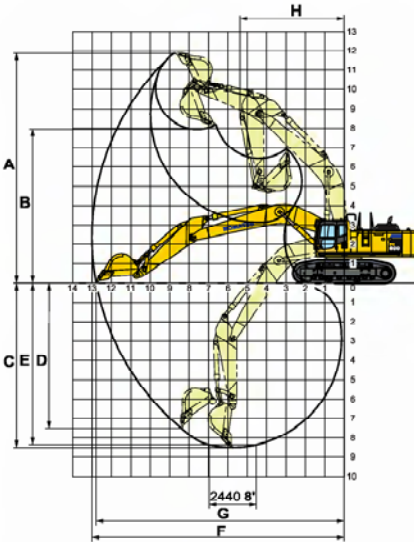

		PC600/600LC-8E0				
		STD		HD		SE
	Boom	7660 25'2"	7660 25'2"	7660 25'2"	7300 23'11"	6600 21'8"
	Arm	3500 11'6"	4300 14'1"	5200 17'1"	3500 11'6"	2900 9'6"
A	Max. digging height	11880 39'0"	12180 40'0"	12560 41'3"	11475 37'8"	11140 36'7"
B	Max. dumping height	7960 26'1"	8245 27'1"	8600 28'3"	7650 25'1"	7210 23'8"
C	Max. digging depth	8490 27'10"	9275 30'5"	10225 33'7"	8165 26'9"	7060 23'2"
D	Max. vertical wall digging depth	7510 24'8"	8375 27'6"	9275 30'5"	6660 21'10"	5630 18'6"
E	Max. digging depth of cut for 8' level	8360 27'5"	9175 30'1"	10125 33'3"	8030 26'4"	6910 22'8"
F	Max. digging reach	13020 42'9"	13740 45'1"	14630 48'0"	12615 41'5"	11550 37'11"
G	Max. digging reach at ground level	12800 42'0"	13555 44'6"	14435 47'4"	12385 40'8"	11300 37'1"
H	Min. swing radius	5370 17'7"	5385 17'8"	5510 18'1"	5090 16'8"	4670 15'4"
	Bucket digging force (SAE)	264 kN 26900 kgf 59,300 lbf				289 kN 29500 kgf 65,040 lbf
	Bucket digging force at power max. (SAE)	285 kN 29100 kgf 64,150 lbf				312 kN 31770 kgf 70,040 lbf
	Arm crowd force (SAE)	222 kN 22600 kgf 49,820 lb	194 kN 19800 kgf 43,650 lb	170 kN 17300 kgf 38,140 lb	222 kN 22600 kgf 49,820 lb	260 kN 26500 kgf 58,420 lb
	Arm crowd force at power max (SAE)	238 kN 24300 kgf 53,570 lb	209 kN 21300 kgf 46,960 lb	182 kN 18600 kgf 41,010 lb	238 kN 24300 kgf 53,570 lb	280 kN 28500 kgf 62,830 lb
	Bucket digging force (ISO)	294 kN 30000 kgf 66,140 lb				336 kN 34300 kgf 75,620 lb
	Bucket digging force at power max. (ISO)	317 kN 32300 kgf 71,210 lb				362 kN 36900 kgf 81,350 lb
	Arm crowd force (ISO)	228 kN 23300 kgf 51,370 lb	202 kN 20600 kgf 45,410 lb	176 kN 17900 kgf 39,460 lb	228 kN 23300 kgf 51,370 lb	272 kN 27700 kgf 61,070 lb
	Arm crowd force at power max (ISO)	246 kN 25100 kgf 55,340 lb	218 kN 22200 kgf 48,940 lb	189 kN 19300 kgf 42,550 lb	246 kN 25100 kgf 55,340 lb	293 kN 29900 kgf 65,920 lb



## BACKHOE BUCKET AND ARM COMBINATION

BUCKET CAPACITY (HEAPED)				WIDTH				WEIGHT (with side cutters) kg lb	TOOTH	ARM LENGTH			
SAE, PCSA m <sup>3</sup> yd <sup>3</sup>		CECE m <sup>3</sup> yd <sup>3</sup>		With Side shrouds, Side cutters mm in		Without Side shrouds, Side cutters mm in				m	ft	in	
use with 7.66m 25'2" boom													
2.0	2.62	1.8	2.35	1430	56.3"	1250	49.2"	2130	4,700	KMAX	○	○	○
2.3	3.01	2.1	2.75	1580	62.2"	1400	55.1"	2260	4,980	KMAX	○	□	—
2.7	3.53	2.4	3.14	1780	70.1"	1600	63.0"	2430	5,360	KMAX	○	—	—
use with 7.3m 23'11" HD boom													
3.5 11'6" 4.3 14'1" 5.2 17'1"													
2.8	3.66	2.5	3.27	1920	75.6"*	1920	75.6"*	3100	6,830	KMAX	○		
3.1	4.05	2.8	3.66	2040	80.3"*	2040	80.3"*	3210	7,080	KMAX	○	**	
use with 6.6m 21'8" SE boom													
2.9 9'6" SE arm													
3.5	4.58	3.1	4.05	2110	83.1"*	2110	83.1"*	3280	7,230	KMAX	○		

These charts are based on over-side stability with fully loaded bucket at maximum reach.

○ : General purpose use, density up to 1.8 t/m<sup>3</sup> 3,000 lb/yd<sup>3</sup> □ : General purpose use, density up to 1.5 t/m<sup>3</sup> 2,500 lb/yd<sup>3</sup>

— : Not useable

\* : Bucket lip width \*\* : Available only to LC crawler



## LOADING SHOVEL DIMENSIONS

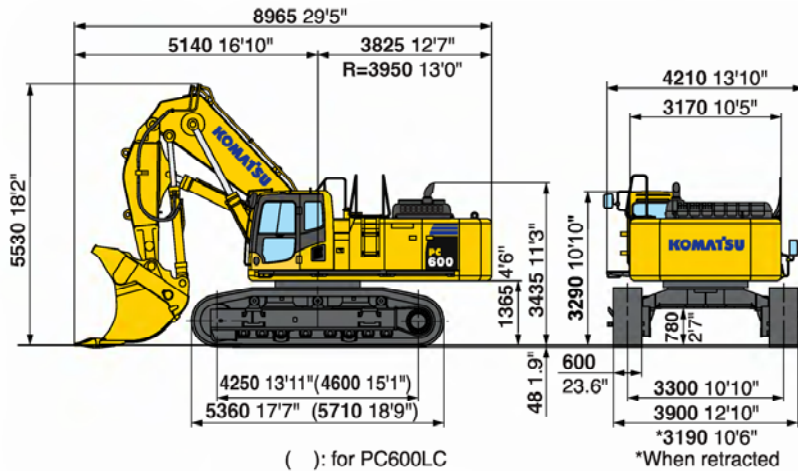

## LOADING SHOVEL WORKING RANGE AND BUCKET SELECTION

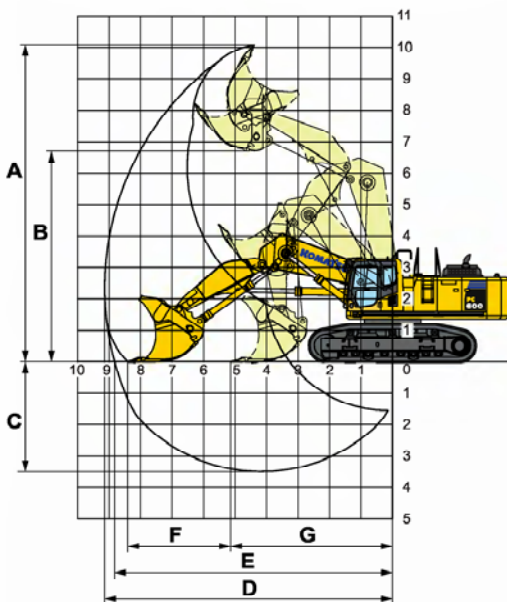

### Working Range

Type of bucket	Bottom dump	
Capacity—heaped	4.0 m <sup>3</sup>	5.2 yd <sup>3</sup>
A Max. cutting height	10090 mm	33'1"
B Max. dumping height	6705 mm	22'0"
C Max. digging depth	3495 mm	11'6"
D Max. digging reach	9190 mm	30'2"
E Max. digging reach at ground level	8850 mm	29'0"
F Level crowding distance	3275 mm	10'9"
G Min. crowd distance	5135 mm	16'10"
Bucket digging force	386 kN	39400 kg 86,860 lb
Arm crowd force	338 kN	34500 kg 76,660 lb

### Bucket Selection

Type of bucket	Bottom dump	
Capacity—heaped	4.0 m <sup>3</sup>	5.2 yd <sup>3</sup>
Width	2090 mm	82.3"
Weight	5700 kg	12,570 lb
No. of bucket teeth	6	
Recommended uses	General-purpose digging and loading	



# LIFTING CAPACITY

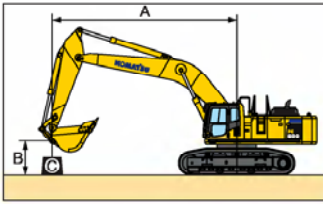

## PC600-8E0

- A: Reach from swing center
- B: Bucket hook height
- C: Lifting capacity
- Cf: Rating over front
- Cs: Rating over side
- ☉: Rating at maximum reach

Boom : 7.66m 25'2", Arm : 3.5m 11'6", Bucket : 2.7m<sup>3</sup> 3.53cu.yd, Shoes : 600mm 24" triple, L mode: "OFF"

unit: kg lb

B	A	☉ MAX		9.1m 29'		7.6m 24'		6.1m 20'		4.6m 15'		3.0m 9'	
		Cf	Cs	Cf	Cs	Cf	Cs	Cf	Cs	Cf	Cs	Cf	Cs
9.1m	29'	*6950	*6950										
		*15,300	*15,300										
7.6m	24'	*6750	*6750	*9400	*9400								
		*14,900	*14,900	*20,700	*20,700								
6.1m	20'	*6850	*6850	*9700	*9700	*10800	*10800						
		*15,100	*15,100	*21,400	*21,400	*23,800	*23,800						
4.6m	15'	*7100	6500	*10400	9450	*12100	*12100	*15000	*15000	*20100	*20100		
		*15,600	14,300	*22,900	20,800	*26,700	*26,700	*33,100	*33,100	*44,300	*44,300		
3.0m	9'	*7600	6050	*11250	8950	*13600	12250	*17850	17400				
		*16,700	13,400	*24,800	19,800	*30,000	27,000	*39,300	38,400				
1.5m	4'	7950	5900	11350	8550	*14800	11600	*19650	16450	*14500	*14500		
		17,600	13,100	25,000	18,900	*32,600	25,600	*43,300	36,300	*32,000	*32,000		
0m	0'	8100	6000	11050	8300	14850	11150	*20200	15850	*16850	*16850		
		17,900	13,300	24,400	18,300	32,800	24,600	*44,500	34,900	*37,100	*37,100		
-1.5m	-4'	8650	6400	10850	8100	14600	10900	*20000	15550	*16550	*16550	*11950	*11950
		19,100	14,100	24,000	17,900	32,200	24,000	*44,100	34,300	*36,500	*36,500	*26,400	*26,400
-3.0m	-9'	9700	7200	10850	8100	14550	10850	*18950	15600	*24500	*24500	*14350	*14350
		21,400	15,900	24,000	17,900	32,100	23,900	*41,700	34,400	*54,000	*54,000	*31,600	*31,600
-4.6m	-15'	*10150	8900			*12950	11050	*16650	*15900	*21150	*21150	*24800	*24800
		*22,400	19,700			*28,500	24,400	*36,700	*35,000	*46,600	*46,600	*54,700	*54,700
-6.1m	-20'	*9500	*9500			*8550	*8550	*12800	*12800	*16300	*16300		
		*21,000	*21,000			*18,800	*18,800	*28,200	*28,200	*35,900	*35,900		

Boom : 7.66m 25'2", Arm : 3.5m 11'6", Bucket : 2.7m<sup>3</sup> 3.53cu.yd, Shoes : 600mm 24" triple, L mode: "ON"

unit: kg lb

B	A	☉ MAX		9.1m 29'		7.6m 24'		6.1m 20'		4.6m 15'		3.0m 9'	
		Cf	Cs	Cf	Cs	Cf	Cs	Cf	Cs	Cf	Cs	Cf	Cs
9.1m	29'	*8550	*8550										
		*18,900	*18,900										
7.6m	24'	*8350	*8350	*11850	10000								
		*18,400	*18,400	*26,100	22,100								
6.1m	20'	*8450	7200	*12250	9800	*13500	*13500						
		*18,600	15,900	*27,000	21,600	*29,700	*29,700						
4.6m	15'	8600	6500	12250	9450	*15100	13000	*18600	*18600	*24650	*24650		
		19,000	14,300	27,000	20,800	*33,300	28,700	*41,000	*41,000	*54,300	*54,300		
3.0m	9'	8100	6050	11750	8950	*16000	12250	*22100	17550				
		17,900	13,400	26,000	19,800	*35,300	27,000	*48,700	38,700				
1.5m	4'	7950	5900	11350	8550	*15350	11600	22050	16450	*17400	*17400		
		17,600	13,100	25,000	18,900	*33,800	25,600	48,600	36,300	*38,400	*38,400		
0m	0'	8100	6000	11050	8300	14850	11150	21350	15850	*20150	*20150		
		17,900	13,300	24,400	18,300	32,800	24,600	47,100	34,900	*44,400	*44,400		
-1.5m	-4'	8650	6400	10850	8100	14600	10900	21050	15550	*19950	*19950	*14450	*14450
		19,100	14,100	24,000	17,900	32,200	24,000	46,400	34,300	*44,000	*44,000	*31,800	*31,800
-3.0m	-9'	9700	7200	10850	8100	14550	10850	21150	15600	*30400	25750	*17400	*17400
		21,400	15,900	24,000	17,900	32,100	23,900	46,600	34,400	*67,100	56,800	*38,300	*38,300
-4.6m	-15'	11900	8900			14800	11050	*20900	15900	*26450	*26000	*29600	*29600
		26,200	19,700			32,600	24,400	*46,100	35,100	*58,300	*57,300	*65,300	*65,300
-6.1m	-20'	*12350	*12350			*11150	*11150	*16350	*16350	*20650	*20650		
		*27,300	*27,300			*24,600	*24,600	*36,000	*36,000	*45,600	*45,600		

Boom : 7.3m 23'11", Arm : 3.5m 11'6", Bucket : 2.8m<sup>3</sup> 3.66cu.yd, Shoes : 600mm 24" triple, L mode: "OFF"

unit: kg lb

B	A	☉ MAX		9.1m 29'		7.6m 24'		6.1m 20'		4.6m 15'		3.0m 9'	
		Cf	Cs	Cf	Cs	Cf	Cs	Cf	Cs	Cf	Cs	Cf	Cs
9.1m	29'	*6500	*6500										
		*14,300	*14,300										
7.6m	24'	*6300	*6300	*8000	*8000								
		*13,900	*13,900	*17,600	*17,600								
6.1m	20'	*6350	*6350	*9550	9400	*10500	*10500						
		*14,000	*14,000	*21,000	20,800	*23,200	*23,200						
4.6m	15'	*6650	*6650	*10150	9100	*11750	*11750	*14500	*14500	*19900	*19900		
		*14,700	*14,700	*22,400	20,000	*25,900	*25,900	*32,000	*32,000	*43,900	*43,900		
3.0m	9'	*7200	6150	*11000	8650	*13300	12050	*17350	*17350	*24100	*24100		
		*15,800	13,600	*24,200	19,100	*29,300	26,500	*38,200	*38,200	*53,200	*53,200		
1.5m	4'	*8000	6050	11050	8300	*14500	11450	*19250	16500	*21300	*21300		
		*17,600	13,300	24,400	18,300	*32,000	25,200	*42,500	36,400	*46,900	*46,900		
0m	0'	8400	6150	10800	8000	14700	11000	*20000	15850	*14600	*14600		
		18,500	13,600	23,800	17,700	32,400	24,200	*44,100	34,900	*32,100	*32,100		
-1.5m	-4'	9000	6600	10650	7850	14450	10750	*19850	15500	*21100	*21100	*14000	*14000
		19,800	14,600	23,400	17,300	31,800	23,700	*43,800	34,200	*46,500	*46,500	*30,900	*30,900
-3.0m	-9'	10250	7600	10650	7900	*14400	10700	*18750	15550	*24750	*24750	*19650	*19650
		22,600	16,700	23,500	17,400	*31,700	23,500	*41,300	34,200	*54,500	*54,500	*43,300	*43,300
-4.6m	-15'	*10350	9650			*12100	10900	*16150	*15750	*21000	*21000	*27400	*27400
		*22,800	21,300			*26,700	24,100	*35,600	*34,700	*46,200	*46,200	*60,400	*60,400
-6.1m	-20'	*9500	*9500					*11450	*11450	*15250	*15250		
		*20,900	*20,900					*25,200	*25,200	*33,700	*33,700		

\*Load is limited by hydraulic capacity rather than tipping. Ratings are based on SAE standard NO. J1097. Rated loads do not exceed 87% of hydraulic lift capacity or 75% of tipping load.



**LIFTING CAPACITY**

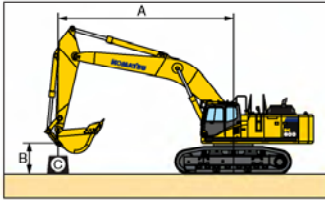

**PC600-8E0**

- A: Reach from swing center
- B: Bucket hook height
- C: Lifting capacity
- Cf: Rating over front
- Cs: Rating over side
- ⊗: Rating at maximum reach

Boom : 7.3m 23'11", Arm : 3.5m 11'6", Bucket : 2.8m<sup>3</sup> 3.66cu.yd, Shoes : 600mm 24" triple, L mode: "ON"

unit: kg lb

B	⊗ MAX		9.1m 29'		7.6m 24'		6.1m 20'		4.6m 15'		3.0m 9'	
	Cf	Cs	Cf	Cs	Cf	Cs	Cf	Cs	Cf	Cs	Cf	Cs
9.1m 29'	*8150 *17,900	*8150 *17,900										
7.6m 24'	*7900 *17,400	*7900 *17,400	*9850 *21,700	9550 21,100								
6.1m 20'	*7950 *17,600	*7450 *16,500	*12150 *26,800	9400 20,800	*13200 *29,100	*13200 *29,100						
4.6m 15'	*8300 *18,300	6650 14,700	11900 26,300	9100 20,000	*14800 *32,600	12750 28,100	*18000 *39,700	*18000 *39,700	*24400 *53,800	*24400 *53,800		
3.0m 9'	8350 18,400	6150 13,600	11450 25,300	8650 19,100	15850 34,900	12050 26,500	*21550 *47,500	17600 38,800	*26500 *58,400	*26500 *58,400		
1.5m 4'	8200 18,100	6050 13,300	11050 24,400	8300 18,300	15200 33,500	11450 25,200	*22150 *48,900	16500 36,400	*23400 *51,600	*23400 *51,600		
0m 0'	8400 18,500	6150 13,600	10800 23,800	8000 17,700	14700 32,400	11000 24,200	*21400 *47,200	15850 34,900	*17800 *39,300	*17800 *39,300		
-1.5m -4'	9000 19,800	6600 14,600	10650 23,400	7850 17,300	14450 31,800	10750 23,700	21050 46,500	15500 34,200	*25450 *56,100	*25450 *56,100	*16950 *37,300	*16950 *37,300
-3.0m -9'	10250 22,600	7600 16,700	10650 23,500	7900 17,400	14400 31,700	10700 23,500	21050 46,500	15550 34,200	*30700 *67,700	*25800 56,900	*23750 *52,400	*23750 *52,400
-4.6m -15'	12950 28,600	9650 21,300			14650 32,300	10900 24,100	*20350 *44,900	15850 34,900	*26250 *57,900	*26100 *57,500	*33500 *73,900	*33500 *73,900
-6.1m -20'	*12450 *27,400	*12450 *27,400					*14750 *32,600	*14750 *32,600	*19500 *43,000	*19500 *43,000		

Boom : 6.6m 21'8", Arm : 2.9m 9'6", Bucket : 3.5m<sup>3</sup> 4.58cu.yd, Shoes : 600mm 24" triple, L mode: "OFF"

unit: kg lb

B	⊗ MAX		9.1m 29'		7.6m 24'		6.1m 20'		4.6m 15'		3.0m 9'	
	Cf	Cs	Cf	Cs	Cf	Cs	Cf	Cs	Cf	Cs	Cf	Cs
9.1m 29'	*9650 *21,300	*9650 *21,300										
7.6m 24'	*9050 *20,000	*9050 *20,000			*11550 *25,500	*11550 *25,500						
6.1m 20'	*8950 *19,700	*8950 *19,700			*11750 *25,900	*11750 *25,900						
4.6m 15'	*9200 *20,300	8250 18,100	*11250 *24,800	9000 19,800	*12700 *28,000	*12700 *28,000	*15450 *34,100	*15450 *34,100	*20100 *44,400	*20100 *44,400		
3.0m 9'	*9800 *21,600	7600 16,700	11500 25,300	8650 19,100	*14000 *30,900	12100 26,600	*17950 *39,600	17650 38,900	*24650 *54,300	*24650 *54,300		
1.5m 4'	9950 22,000	7400 16,400	11150 24,600	8350 18,400	*15000 *33,100	11500 25,400	*19750 *43,500	16750 36,900	*26900 *59,400	25900 57,100		
0m 0'	10300 22,700	7650 16,900	10900 24,100	8100 17,900	14850 32,800	11100 24,500	*20250 *44,600	16100 35,500	*26150 *57,700	25000 55,100		
-1.5m -4'	11250 24,800	8400 18,500	10850 24,000	8050 17,800	14650 32,300	10900 24,100	*19800 *43,600	15800 34,900	*26750 *58,900	*25950 *57,200	*18800 *41,500	*18800 *41,500
-3.0m -9'	*11500 *25,400	9950 22,000			*13250 *29,200	11000 24,300	*17950 *39,600	15950 35,100	*23750 *52,400	*23750 *52,400	*24700 *54,500	*24700 *54,500
-4.6m -15'	*10650 *23,500	*10650 *23,500					*13500 *29,800	*13500 *29,800	*18250 *40,300	*18250 *40,300	*23100 *50,900	*23100 *50,900

Boom : 6.6m 21'8", Arm : 2.9m 9'6", Bucket : 3.5m<sup>3</sup> 4.58cu.yd, Shoes : 600mm 24" triple, L mode: "ON"

unit: kg lb

B	⊗ MAX		9.1m 29'		7.6m 24'		6.1m 20'		4.6m 15'		3.0m 9'	
	Cf	Cs	Cf	Cs	Cf	Cs	Cf	Cs	Cf	Cs	Cf	Cs
9.1m 29'	*11800 *26,000	*11800 *26,000										
7.6m 24'	*11100 *24,400	*11100 *24,400			*14400 *31,800	13500 29,800						
6.1m 20'	*10950 *24,200	9400 20,700			*14700 *32,400	13300 29,300						
4.6m 15'	10900 24,000	8250 18,100	11800 26,100	9000 19,800	*15900 *35,100	12750 28,200	*19100 *42,100	18950 41,800	*24600 *54,300	*24600 *54,300		
3.0m 9'	10150 22,300	7600 16,700	11500 25,300	8650 19,100	15900 35,100	12100 26,600	*22250 *49,000	17750 39,200	*30350 *66,900	28050 61,800		
1.5m 4'	9950 22,000	7400 16,400	11150 24,600	8350 18,400	15300 33,700	11500 25,400	22450 49,500	16750 36,900	*26900 *59,400	25900 57,100		
0m 0'	10300 22,700	7650 16,900	10900 24,100	8100 17,900	14850 32,800	11100 24,500	21700 47,900	16100 35,500	*26150 *57,700	25000 55,100		
-1.5m -4'	11250 24,800	8400 18,500	10850 24,000	8050 17,800	14650 32,300	10900 24,100	21400 47,200	15800 34,900	*33050 *72,800	26100 57,600	*22500 *49,600	*22500 *49,600
-3.0m -9'	13350 29,400	9950 22,000			14750 32,500	11000 24,300	21550 47,500	15950 35,100	*29500 *65,100	26450 58,300	*31000 *68,400	*31000 *68,400
-4.6m -15'	*13750 *30,400	*13750 *30,400					*17200 *37,900	*16300 *36,000	*23000 *50,800	*23000 *50,800	*29100 *64,200	*29100 *64,200

\*Load is limited by hydraulic capacity rather than tipping. Ratings are based on SAE standard NO. J1097. Rated loads do not exceed 87% of hydraulic lift capacity or 75% of tipping load.





**LIFTING CAPACITY**

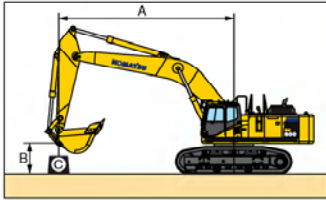

**PC600LC-8E0**

- A: Reach from swing center
- B: Bucket hook height
- C: Lifting capacity
- Cf: Rating over front
- Cs: Rating over side
- ☉: Rating at maximum reach

Boom : 7.66m 25'2", Arm : 3.5m 11'6", Bucket : 2.7m<sup>3</sup> 3.53cu.yd, Shoes : 600mm 24" triple, L mode : "OFF" unit: kg lb

B \ A	☉ MAX		9.1m 29'		7.6m 24'		6.1m 20'		4.6m 15'		3.0m 9'	
	Cf	Cs	Cf	Cs	Cf	Cs	Cf	Cs	Cf	Cs	Cf	Cs
9.1m 29'	*6950 *15,300	*6950 *15,300										
7.6m 24'	*6750 *14,900	*6750 *14,900	*9400 *20,700	*9400 *20,700								
6.1m 20'	*6850 *15,100	*6850 *15,100	*9700 *21,400	*9700 *21,400	*10800 *23,800	*10800 *23,800						
4.6m 15'	*7100 *15,600	6650 14,600	*10400 *22,900	9600 21,200	*12100 *26,700	*12100 *26,700	*15000 *33,100	*15000 *33,100	*20100 *44,300	*20100 *44,300		
3.0m 9'	*7600 *16,700	6200 13,700	*11250 *24,800	9150 20,200	*13600 *30,000	12450 27,500	*17850 *39,300	*17600 *38,900				
1.5m 4'	*8300 *18,400	6050 13,400	*11950 *26,300	8750 19,300	*14800 32,600	11800 26,100	*19650 *43,300	16750 37,000	*14500 *32,000	*14500 *32,000		
0m 0'	9350 20,600	6150 13,600	*12350 *27,200	8450 18,600	*15400 *34,000	11350 25,100	*20200 *44,500	16150 35,600	*16850 *37,100	*16850 *37,100		
-1.5m -4'	9950 22,000	6550 14,500	*12300 *27,100	8300 18,300	*15450 *34,000	11100 24,500	*20000 *44,100	15850 35,000	*16550 *36,500	*16550 *36,500	*11950 *26,400	*11950 *26,400
-3.0m -9'	*10150 *22,400	7400 16,300	*11600 *25,500	8300 18,300	*14800 *32,600	11100 24,400	*18950 *41,700	15900 35,100	*24500 *54,000	*24500 *54,000	*14350 *31,600	*14350 *31,600
-4.6m -15'	*10150 *22,400	9100 20,100			*12950 *28,500	11300 24,900	*16650 *36,700	*16100 *35,500	*21150 *46,600	*21150 *46,600	*24800 *54,700	*24800 *54,700
-6.1m -20'	*9500 *21,000	*9500 *21,000			*8550 *18,800	8550 18,800	*12800 *28,200	*12800 *28,200	*16300 *35,900	*16300 *35,900		

Boom : 7.66m 25'2", Arm : 3.5m 11'6", Bucket : 2.7m<sup>3</sup> 3.53cu.yd, Shoes : 600mm 24" triple, L mode : "ON" unit: kg lb

B \ A	☉ MAX		9.1m 29'		7.6m 24'		6.1m 20'		4.6m 15'		3.0m 9'	
	Cf	Cs	Cf	Cs	Cf	Cs	Cf	Cs	Cf	Cs	Cf	Cs
9.1m 29'	*8550 *18,900	*8550 *18,900										
7.6m 24'	*8350 *18,400	*8350 *18,400	*11850 *26,100	10200 22,500								
6.1m 20'	*8450 *18,600	7350 16,200	*12250 *27,000	10000 22,000	*13500 *29,700	*13500 *29,700						
4.6m 15'	*8750 *19,300	6650 14,600	*13100 *28,900	9600 21,200	*15100 *33,300	13250 29,200	*18600 *41,000	*18600 *41,000	*24650 *54,300	*24650 *54,300		
3.0m 9'	9300 20,500	6200 13,700	13450 29,600	9150 20,200	*17000 *37,500	12450 27,500	*22100 *48,700	17850 39,400				
1.5m 4'	9150 20,200	6050 13,400	13000 28,700	8750 19,300	17600 38,800	11800 26,100	*24350 *53,700	16750 37,000	*17400 *38,400	*17400 *38,400		
0m 0'	9350 20,600	6150 13,600	12700 28,000	8450 18,600	17100 37,700	11350 25,100	24800 54,600	16150 35,600	*20150 *44,400	*20150 *44,400		
-1.5m -4'	9950 22,000	6550 14,500	12500 27,600	8300 18,300	16800 37,100	11100 24,500	24450 54,000	15850 35,000	*19950 *44,000	*19950 *44,000	*14450 *31,800	*14450 *31,800
-3.0m -9'	11150 24,600	7400 16,400	12500 27,600	8300 18,300	16800 37,000	11100 24,400	*23650 *52,100	15900 35,100	*30400 *67,100	26200 57,800	*17400 *38,300	*17400 *38,300
-4.6m -15'	*13000 *28,700	9100 20,100			*16400 *36,100	11300 24,900	*20900 *46,100	16200 35,800	*26450 *58,300	*26450 *58,300	*29600 *65,300	*29600 *65,300
-6.1m -20'	*12350 *27,300	*12350 *27,300			*11150 *24,600	*11150 *24,600	*16350 *36,000	*16350 *36,000	*20650 *45,600	*20650 *45,600		

Boom : 7.3m 23'11", Arm : 3.5m 11'6", Bucket : 2.8m<sup>3</sup> 3.66cu.yd, Shoes : 600mm 24" triple, L mode : "OFF" unit: kg lb

B \ A	☉ MAX		9.1m 29'		7.6m 24'		6.1m 20'		4.6m 15'		3.0m 9'	
	Cf	Cs	Cf	Cs	Cf	Cs	Cf	Cs	Cf	Cs	Cf	Cs
9.1m 29'	*6500 *14,300	*6500 *14,300										
7.6m 24'	*6300 *13,900	*6300 *13,900	*8000 *17,600	*8000 *17,600								
6.1m 20'	*6350 *14,000	*6350 *14,000	*9550 *21,000	*9550 *21,000	*10500 *23,200	*10500 *23,200						
4.6m 15'	*6650 *14,700	*6650 *14,700	*10150 *22,400	9250 20,400	*11750 *25,900	*11750 *25,900	*14500 *32,000	*14500 *32,000	*19900 *43,900	*19900 *43,900		
3.0m 9'	*7200 *15,800	6300 13,900	*11000 *24,200	8850 19,500	*13300 *29,300	12250 27,000	*17350 *38,200	*17350 *38,200	*24100 *53,200	*24100 *53,200		
1.5m 4'	*8000 *17,600	6150 13,600	*11650 *25,700	8450 18,700	*14500 *32,000	11650 25,700	*19250 *42,500	16800 37,100	*21300 *46,900	*21300 *46,900		
0m 0'	*9200 *20,300	6300 13,900	*12050 *26,600	8200 18,100	*15150 *33,400	11200 24,700	*20000 *44,100	16150 35,600	*14600 *32,100	*14600 *32,100		
-1.5m -4'	*10200 *22,400	6800 14,900	*11900 *26,300	8050 17,700	*15150 *33,400	10950 24,100	*19850 *43,800	15800 34,900	*21100 *46,500	*21100 *46,500	*14000 *30,900	*14000 *30,900
-3.0m -9'	*10350 *22,900	7750 17,100	*10900 *24,100	8050 17,800	*14400 *31,700	10900 24,000	*18750 *41,300	15850 34,900	*24750 *54,500	*24750 *54,500	*19650 *43,300	*19650 *43,300
-4.6m -15'	*10350 *22,800	9850 21,800			*12100 *26,700	11150 24,800	*16150 *35,600	*16050 *35,400	*21000 *46,200	*21000 *46,200	*27400 *60,400	*27400 *60,400
-6.1m -20'	*9500 *20,900	*9500 *20,900					*11450 *25,200	*11450 *25,200	*15250 *33,700	*15250 *33,700		

\*Load is limited by hydraulic capacity rather than tipping. Ratings are based on SAE standard NO. J1097. Rated loads do not exceed 87% of hydraulic lift capacity or 75% of tipping load.



# LIFTING CAPACITY

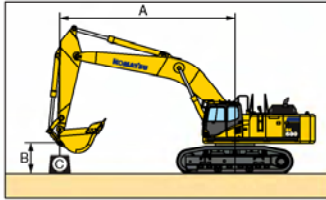

## PC600LC-8E0

- A: Reach from swing center
- B: Bucket hook height
- C: Lifting capacity
- Cf: Rating over front
- Cs: Rating over side
- ☉: Rating at maximum reach

Boom : 7.3m 23'11", Arm : 3.5m 11'6", Bucket : 2.8m<sup>3</sup> 3.66cu.yd, Shoes : 600mm 24" triple, L mode: "ON" unit: kg lb

B	A	☉ MAX		9.1m 29'		7.6m 24'		6.1m 20'		4.6m 15'		3.0m 9'	
		Cf	Cs	Cf	Cs	Cf	Cs	Cf	Cs	Cf	Cs	Cf	Cs
9.1m	29'	*8150	*8150										
		*17,900	*17,900										
7.6m	24'	*7900	*7900	*9850	9750								
		*17,400	*17,400	*21,700	21,500								
6.1m	20'	*7950	7650	*12150	9600	*13200	*13200						
		*17,600	16,800	*26,800	21,100	*29,100	*29,100						
4.6m	15'	*8300	6800	*12900	9250	*14800	13000	*18000	*18000	*24400	*24400		
		*18,300	15,000	*28,400	20,400	*32,600	28,600	*39,700	*39,700	*53,800	*53,800		
3.0m	9'	*8900	6300	13150	8850	*16700	12250	*21550	17900	*26500	*26500		
		*19,700	13,900	29,000	19,500	*36,800	27,000	*47,500	39,400	*58,400	*58,400		
1.5m	4'	9450	6150	12750	8450	17450	11650	*23950	16800	*23400	*23400		
		20,900	13,600	28,100	18,700	38,500	25,700	*52,800	37,100	*51,600	*51,600		
0m	0'	9700	6300	12450	8200	16950	11200	24750	16150	*17800	*17800		
		21,400	13,900	27,400	18,100	37,400	24,700	54,600	35,600	*39,300	*39,300		
-1.5m	-4'	10400	6800	12300	8050	16700	10950	*24500	15800	*25450	*25450	*16950	*16950
		22,900	14,900	27,100	17,700	36,800	24,100	*54,000	34,900	*56,100	*56,100	*37,300	*37,300
-3.0m	-9'	11850	7750	12300	8050	16600	10900	*23450	15850	*30700	*26250	*23750	*23750
		26,100	17,100	27,100	17,800	36,600	24,000	*51,700	34,900	*67,700	57,900	*52,400	*52,400
-4.6m	-15'	*13350	9850			*15450	11150	*20350	16150	*26250	*26250	*33500	*33500
		*29,400	21,800			*34,100	24,600	*44,900	35,600	*57,900	*57,900	*73,900	*73,900
-6.1m	-20'	*12450	*12450					*14750	*14750	*19500	*19500		
		*27,400	*27,400					*32,600	*32,600	*43,000	*43,000		

Boom : 6.6m 21'8", Arm : 2.9m 9'6", Bucket : 3.5m<sup>3</sup> 4.58cu.yd, Shoes : 600mm 24" triple, L mode: "OFF" unit: kg lb

B	A	☉ MAX		9.1m 29'		7.6m 24'		6.1m 20'		4.6m 15'		3.0m 9'	
		Cf	Cs	Cf	Cs	Cf	Cs	Cf	Cs	Cf	Cs	Cf	Cs
9.1m	29'	*9650	*9650										
		*21,300	*21,300										
7.6m	24'	*9050	*9050			*11550	*11550						
		*20,000	*20,000			*25,500	*25,500						
6.1m	20'	*8950	*8950			*11750	*11750						
		*19,700	*19,700			*25,900	*25,900						
4.6m	15'	*9200	8400	*11250	9150	*12700	*12700	*15450	*15450	*20100	*20100		
		*20,300	18,500	*24,800	20,200	*28,000	*28,000	*34,100	*34,100	*44,400	*44,400		
3.0m	9'	*9800	7750	*11750	8850	*14000	12300	*17950	17900	*24650	*24650		
		*21,600	17,100	*25,900	19,500	*30,900	27,100	*39,600	39,500	*54,300	*54,300		
1.5m	4'	*10800	7600	*12150	8500	*15000	11750	*19750	17050	*26900	26350		
		*23,800	16,700	*26,800	18,800	*33,100	25,900	*43,500	37,600	*59,400	58,100		
0m	0'	*11500	7800	*12200	8300	*15500	11350	*20250	16400	*26150	25450		
		*25,400	17,200	*26,900	18,300	*34,000	25,000	*44,600	36,200	*57,700	56,100		
-1.5m	-4'	*11600	8550	*11300	8250	*15000	11150	*19800	16100	*26750	*26400	*18800	*18800
		*25,600	18,900	*24,900	18,200	*33,100	24,600	*43,600	35,500	*58,900	*58,200	*41,500	*41,500
-3.0m	-9'	*11500	10150			*13250	11250	*17950	16250	*23750	*23750	*24700	*24700
		*25,400	22,400			*29,200	24,800	*39,600	35,800	*52,400	*52,400	*54,500	*54,500
-4.6m	-15'	*10650	*10650					*13500	*13500	*18250	*18250	*23100	*23100
		*23,500	*23,500					*29,800	*29,800	*40,300	*40,300	*50,900	*50,900

Boom : 6.6m 21'8", Arm : 2.9m 9'6", Bucket : 3.5m<sup>3</sup> 4.58cu.yd, Shoes : 600mm 24" triple, L mode: "ON" unit: kg lb

B	A	☉ MAX		9.1m 29'		7.6m 24'		6.1m 20'		4.6m 15'		3.0m 9'	
		Cf	Cs	Cf	Cs	Cf	Cs	Cf	Cs	Cf	Cs	Cf	Cs
9.1m	29'	*11800	*11800										
		*26,000	*26,000										
7.6m	24'	*11100	*11100			*14400	13700						
		*24,400	*24,400			*31,800	30,300						
6.1m	20'	*10950	9600			*14700	13500						
		*24,200	21,100			*32,400	29,800						
4.6m	15'	*11250	8400	13500	9150	*15900	13000	*19100	*19100	*24650	*24600		
		*24,800	18,500	29,800	20,200	*35,100	28,700	*42,100	*42,100	*54,300	*54,300		
3.0m	9'	11650	7750	13150	8850	*17500	12300	*22250	18050	*30350	28500		
		25,700	17,100	29,000	19,500	*38,600	27,100	*49,000	39,800	*66,900	62,800		
1.5m	4'	11450	7600	12800	8500	17550	11750	*24450	17050	*26900	26350		
		25,300	16,700	28,300	18,800	38,700	25,900	*54,000	37,600	*59,400	58,100		
0m	0'	11850	7800	12550	8300	17150	11350	25100	16400	*26150	25450		
		26,100	17,200	27,700	18,300	37,800	25,000	55,300	36,200	*57,700	56,100		
-1.5m	-4'	12950	8550	12500	8250	16900	11150	*24650	16100	*33050	26550	*22500	*22500
		28,600	18,900	27,600	18,200	37,300	24,600	*54,300	35,500	*72,800	58,600	*49,600	*49,600
-3.0m	-9'	*14750	10150			*16800	11250	*22450	16250	*29500	26900	*31000	*31000
		*32,500	22,400			*37,000	24,800	*49,500	35,800	*65,100	59,300	*68,400	*68,400
-4.6m	-15'	*13750	*13750					*17200	*16600	*23000	*23000	*29100	*29100
		*30,400	*30,400					*37,900	*36,600	*50,800	*50,800	*64,200	*64,200

\*Load is limited by hydraulic capacity rather than tipping. Ratings are based on SAE standard NO. J1097. Rated loads do not exceed 87% of hydraulic lift capacity or 75% of tipping load.



### Backhoe

Specs shown include the following equipment:  
PC600-8E0 : Boom **7660 mm 25'2"**, Arm **3500 mm 11'6"**,  
Bucket **2.7 m<sup>3</sup> 3.53 yd<sup>3</sup>**, Shoes **600 mm 24"** triple grouser

#### 3 Kits Transportation

**Work equipment assembly (Backhoe)**  
Weight : 12.5 t 13.8 U.S.ton

**Boom**  
  
4.9t : 7920 x 2040 x 1190  
5.4U.S.ton : 26'0" x 6'8" x 3'11"

**Arm**  
  
3.3t : 4870 x 1210 x 650  
3.6U.S.ton : 16'0" x 4'0" x 2'2"

**Bucket**  
  
2.5t : 2150 x 1780 x 1780  
2.8U.S.ton : 7'1" x 5'10" x 5'10"

**Boom cylinder & Arm cylinder**  
  
Total 1.75 t 1.9 U.S.ton

#### 4 Kits Transportation

**Work equipment assembly (Backhoe)**  
Weight : 12.5 t 13.8 U.S.ton

**Boom**  
  
4.9t : 7920 x 2040 x 1190  
5.4U.S.ton : 26'0" x 6'8" x 3'11"

**Arm**  
  
3.3t : 4870 x 1210 x 650  
3.6U.S.ton : 16'0" x 4'0" x 2'2"

**Bucket**  
  
2.5t : 2150 x 1780 x 1780  
2.8U.S.ton : 7'1" x 5'10" x 5'10"

**Boom cylinder & Arm cylinder**  
  
Total 1.7 t 1.9 U.S.ton

### Loading Shovel

Specs shown include the following equipment:  
PC600-8E0 : Boom **4000 mm 13'1"**, Arm **3000 mm 9'10"**,  
Bucket **4.0 m<sup>3</sup> 5.2 yd<sup>3</sup>**, Shoes **600 mm 24"** double grouser

#### 3 Kits Transportation

**Work equipment assembly (Loading shovel)**  
Width : 2090 6'10"  
Weight : 16.5t 18.2U.S.ton

**Base machine**  
  
3470 11'5"  
PC600-8E0 6270 20'7"  
PC600LC-8E0 6440 21'2"  
Width : 3195 10'6"  
Weight : PC600-8E0 34.4t 37.9U.S.ton  
PC600LC-8E0 35.4t 39.0U.S.ton

**Upper structure**  
  
5170 17'0"  
2660 8'9"  
Width : 3170 10'5"  
Weight : 18.4t 20.3U.S.ton

**Undercarriage**  
  
1260 4'2"  
875 2'10"  
PC600-8E0 5340 17'6"  
PC600LC-8E0 5690 18'8"  
Weight : PC600-8E0 16.0t [8.0t x 2] 17.6U.S.ton [8.8U.S.ton x 2]  
PC600LC-8E0 17.0t [8.5t x 2] 18.7U.S.ton [9.4U.S.ton x 2]

**Base machine**  
  
3470 11'5"  
PC600-8E0 6270 20'7"  
PC600LC-8E0 6440 21'2"  
Width : 3195 10'6"  
Weight : PC600-8E0 34.4t 37.9U.S.ton  
PC600LC-8E0 35.4t 39.0U.S.ton

**Others**  
Weight : 12.3t 13.6U.S.ton

Weight : 10.75t 11.8U.S.ton

**Others**  
Weight : 12.3t 13.6U.S.ton

Weight : 10.75t 11.8U.S.ton

**Others**  
Weight : 12.3t 13.6U.S.ton

Weight : 10.75t 11.8U.S.ton



## STANDARD EQUIPMENT

### ENGINE AND RELATED ITEMS:

- Air cleaner, double element, dry
- Engine, Komatsu SAA6D140E-5
- Variable speed cooling fan, with fan guard

### ELECTRICAL SYSTEM:

- Alternator, 60 amp, 24 V
- Auto decelerator and auto idling system
- Batteries, 170 Ah, 2 x 12 V
- Starting motors, 11kW
- Working lights 2 (boom and right front)

### UNDERCARRIAGE:

- Hydraulic track adjusters (each side)
- Sealed track
- 8 track/3 carrier rollers (each side)
- 9 track/3 carrier rollers (each side)(LC)
- **600 mm** 24" triple grouser
- Variable track gauge

### GUARDS AND COVERS:

- Dust-proof net for radiator and oil cooler
- Pump/engine room partition cover
- Strengthened revolving frame underguard
- Travel motor guards

### OPERATOR ENVIRONMENT:

- Cab with pull-up type front window
- Damper mount, all-weather, sound-suppressed cab with tinted safety glass windows, lockable door, intermittent window wiper and washer, floormat, cigarette lighter and ashtray
- Multi-function color monitor, fuel control dials, service meter, gauges (coolant temperature, hydraulic oil temperature and fuel level), caution lights (electric charge, engine oil pressure, and air cleaner clogging), indicator lights (engine preheating and swing lock light) level check lights (coolant and engine oil level), self-diagnostic system with trouble data memory
- Seat, fully adjustable with suspension
- Rear view mirror (RH)

### HYDRAULIC CONTROLS:

- Control levers and pedals for steering and travel with PPC system
- Control levers, wrist control levers for arm, boom, bucket, and swing with PPC system
- Control valves, 5+4 spools (boom, arm, bucket, swing, and travel)
- Fully hydraulic, with Open-Center Load-Sensing (OLSS) and engine speed sensing (pump and engine mutual control system)
- In-line filter
- Lifting mode system
- Oil cooler
- One axial piston motor per track for travel with counter balance valve
- One gear pump for control circuit
- Power max function
- Two axial piston motors for swing with single-stage relief valve
- Two-mode setting for boom
- Two variable capacity piston pumps

### DRIVE AND BRAKE SYSTEM:

- Brakes, hydraulic lock travel brakes, oil disc parking
- Hydrostatic two travel speed system with planetary triple reduction final drive

### OTHER STANDARD EQUIPMENT:

- Anti-slip plates
- Automatic swing holding brake
- Catwalk
- Counterweight, **10750 kg** 23,700 lb
- Horn, electric
- Large handrails
- Marks and plates, English
- One-touch engine oil drainage
- Paint, Komatsu standard
- PM tune-up service connector
- Rear reflector
- Travel alarm



## OPTIONAL EQUIPMENT

- |  |  |  |
|--|--|--|
| <ul style="list-style-type: none"> <li>• Alternator, 90 amp, 24 V</li> <li>• Arms (Backhoe):           <ul style="list-style-type: none"> <li>—<b>3500 mm</b> 11'6" arm assembly</li> <li>—<b>3500 mm</b> 11'6" HD arm assembly</li> <li>—<b>4300 mm</b> 14'1" arm assembly</li> <li>—<b>5200 mm</b> 17'1" arm assembly</li> <li>—<b>2900 mm</b> 9'6" SE arm assembly</li> </ul> </li> <li>• Auto air conditioner</li> <li>• Booms (Backhoe):           <ul style="list-style-type: none"> <li>—<b>7660 mm</b> 25'2" boom assembly</li> <li>—<b>7300 mm</b> 23'11" HD boom assembly</li> <li>—<b>6600 mm</b> 21'8" SE boom assembly</li> </ul> </li> <li>• Cab front guard (ISO 10262 level 2)</li> <li>• Cab with fixed front window</li> <li>• Counterweight <b>13500kg</b> 29,800 lb</li> </ul> | <ul style="list-style-type: none"> <li>• Electric pump, grease gun with indicator</li> <li>• 12V electric supply</li> <li>• Fire extinguisher</li> <li>• Full length track guard</li> <li>• General tool kit</li> <li>• Interconnected horn and warning light</li> <li>• Large-capacity batteries</li> <li>• Loading shovel attachments</li> <li>• Lower wiper</li> <li>• OPG top guard</li> <li>• Radio AM/FM</li> <li>• Rain visor</li> <li>• Rear view mirror (LH)</li> <li>• Rear view monitoring system</li> <li>• Rock protectors (undercarridge)</li> </ul> | <ul style="list-style-type: none"> <li>• Seat belt <b>78 mm</b> 3", <b>50 mm</b> 2"</li> <li>• Service valve</li> <li>• Shoes:           <ul style="list-style-type: none"> <li>—<b>600 mm</b> 24" double grouser for backhoe</li> <li>—<b>750 mm</b> 29.5" triple grouser for backhoe</li> <li>—<b>900 mm</b> 35.5" triple grouser for PC600LC backhoe only</li> </ul> </li> <li>• Spare parts for first service</li> <li>• Step light with timer</li> <li>• Sun visor</li> <li>• Track frame undercover (center)</li> <li>• Vandalism protection locks</li> <li>• Working lights 2 (on cab)</li> </ul> |
|--|--|--|

www.Komatsu.com

Printed in Japan 201003 IP.As(10)

# KOMATSU®

CEN00403-00

Materials and specifications are subject to change without notice.  
**KOMATSU** is a trademark of Komatsu Ltd. Japan.