

# KOMATSU

## PC78UU-11



Photos may include optional equipment.

Hydraulic excavator

**Horsepower**

Gross:50.7 kW 68.0 HP/1900 min<sup>-1</sup>  
Net:50.6 kW 67.8 HP/1850 min<sup>-1</sup>

**Operating weight**

8550 kg (Triple grouser)

**Bucket capacity**

0.09 m<sup>3</sup> - 0.34 m<sup>3</sup>

# PC78UU-11





# Providing more power and functionality to working machines

## Introduction of stress-free machines for working people

### Ecology & economy features

- A new high output 2.4-liter engine **New**
- Work efficiency 14% UP  
(Compared to the PC78UU-10) **New**
- Low noise 2.4 dB(A) reduction  
(Compared to the PC78UU-10) **New**

### Workability features

- Automatic interference avoidance system **New**
- Hydraulic flow to the attachment 12% up  
(Compared to the PC78UU-10) **New**
- Automated attachment conversion using monitor **New**
- Better blade work **New**
- LED lamp as standard equipment **New**
- Additional working light (on cab) as optional **New**

### Safety features & Information and Communication Technology (ICT)

- KomVision **New**

### Comfortable features

- Suspension seat as standard equipment **New**
- Multifunction audio **New**

### Maintenance & robustness features

- Enlarged body cover apertures **New**
- Easy to clean cooling unit area **New**
- Centralized configuration of fuel/oil filters **New**
- Enclosed cooling system **New**



#### Horsepower

**Gross: 50.7 kW 68.0 HP/1900 min<sup>-1</sup>**

**Net: 50.6 kW 67.8 HP/1850 min<sup>-1</sup>**

#### Operating weight

**8550 kg (Triple grouser)**

#### Bucket capacity

**0.09 m<sup>3</sup> - 0.34 m<sup>3</sup>**

## Ecology & economy features

### A new high output 2.4-liter engine New

Komatsu's new, in house-developed high output 2.4-liter engine can meet all user requirements. Its digging efficiency and environmental performance are top-of the class, offering both high power and low fuel consumption even with a more compact engine. Centralizing filtering reduces the time and effort spent on maintenance.

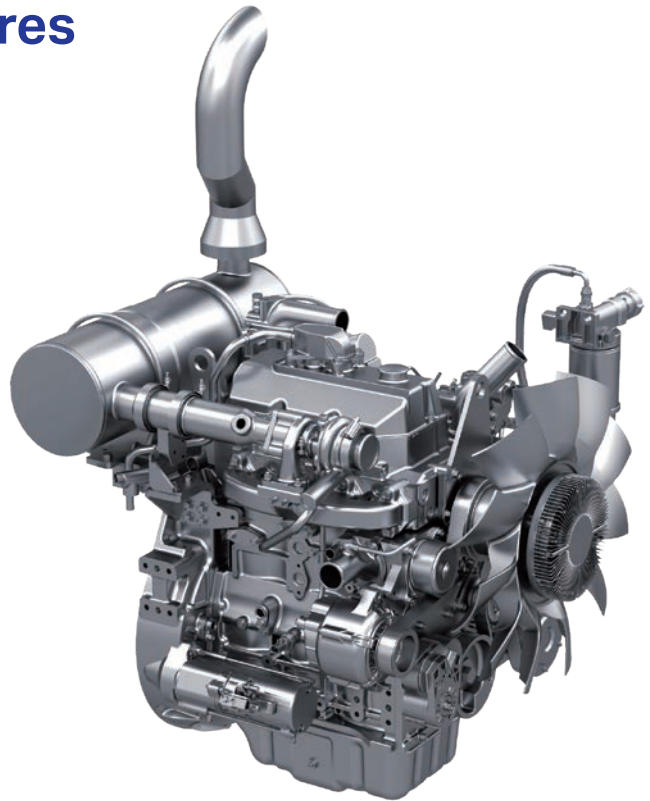

### Work efficiency greatly improved New

Total vehicle control has been further improved to control the main unit in an optimal way according to the working conditions. The work efficiency has also been greatly increased thanks to features such as variable matching control of the engine and hydraulic system, loss reduction in the hydraulic circuit, and the use of a fan clutch.

#### Work efficiency

**14% UP**

Compared to the PC78UU-10  
The fuel efficiency data is based on the results of in-house tests.

### Low noise New

A more compact engine produces space for a fan clutch system allowing engine and hydraulic system turning using a variable matching control system which reduces noise, and makes the machine environmentally friendly.

#### Surrounding noise

**Reduced 2.4 dB (A)**

Compared to the PC78UU-10  
The surrounding noise data is based on the results of in-house tests.

### Technologies applied to new engine

- **Komatsu Diesel Oxidation Catalyst (KDOC)**

Komatsu has designed and developed a simple and high efficiency diesel oxidation catalyst. The system makes it possible to eliminate the need for regeneration and simplifies the engine control system. High performance muffler is also integrated and it contributes the engine noise reduction.

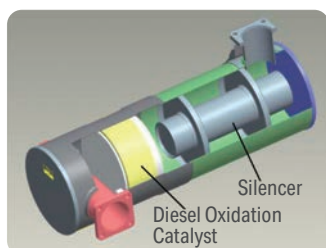

- **Electronic control system**

The electronic control system performs high-speed processing of all signals from sensors installed in the vehicle and engine to control equipment in different conditions of use. Conditions of the engine are displayed via an on-board network on the monitor inside the cab, providing necessary information to the operator. Furthermore, managing the information via KOMTRAX helps customers engage in appropriate maintenance.

- **Heavy-duty high-pressure common rail fuel injection system**

The system is designed to achieve an optimal injection of high-pressure fuel by means of computerized control, thereby bringing close to complete combustion to reduce PM emissions. While this technology is already used in current engines, the new system realizes a higher-pressure injection, thereby reducing both PM emissions and fuel consumption at entire engine operating conditions.

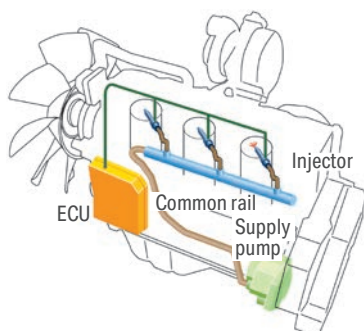

- **Cooled Exhaust Gas Recirculation (EGR)**

Cooled EGR, a technology well-proven in existing Komatsu engines, reduces NOx emissions. These components ensure reliable performance during the demanding work conditions of construction equipment.

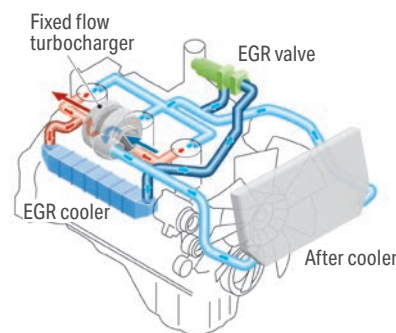

### Further promotion of cleanliness and economy

- **Auto idle stop function**

When the engine has been idling for a certain time, the engine stops automatically to reduce unnecessary fuel consumption and exhaust emissions. The duration before the engine shutdown can be easily programmed.



- **Working mode selectable**

- **ECO guidance**

- **ECO gauge & fuel consumption gauge**

- **Auto-decelerator**



## Workability features

### Offset boom to increase the accuracy and efficiency of side excavation work

Equipped with an offset boom with maximum boom range of 1050 mm on both sides. Now it is possible to accurately and efficiently perform the side excavation work in narrow areas and walls together with the rear ultra-small turning.

#### Outside track excavation

Right **410 mm**

Left **120 mm**



- Equipped with a swing return prevention valve  
A swivel motor with a swinging return restraining valve with smooth turning stop as standard build. It is easy to position the working machine and it helps prevent the load of the bucket from spilling out.



## UU unique advanced systems that facilitate accurate operations

Work conditions in urban areas are often difficult.

In particular, machines from the UU series are often required to work in narrow areas with various restrictions.

PC78UU-11 is equipped with advanced systems unique to the UU series particularly adapted to these work conditions.

These systems provide superior workability and great versatility and facilitate work in urban areas.

- Automatic interference avoidance system **New**

In addition to the existing interference prevention device that automatically stops the arm when the bucket comes close to the operator cab, a new interference avoidance system has been introduced. With this system, the arm automatically avoids the cab without stopping the work equipment.

This system allows smoother operations.

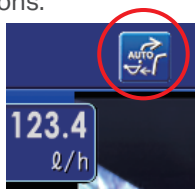

The automatic interference avoidance indicator is lit blue on the monitor screen when the automatic interference avoidance system is on.



**Interference avoidance area**  
**Automatic stop area**

\* The bucket does not operate automatically with the automatic interference avoidance system. In the picture, the bucket is operated manually.

- Digital depth display

Ditching, trenching, or digging is even more efficient with this automatic depth measurement system.

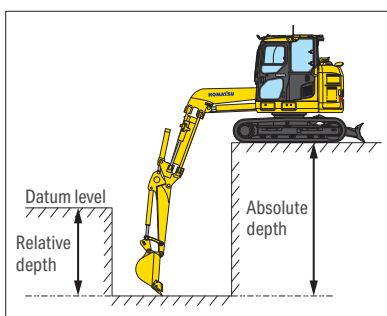

- Height limiter

An adjustable boom height limiter can be set prior to operation.



## Workability features

### Better blade work

- Improved blade efficiency moving soil **New**  
The shape and profile of the blade has been optimized to reduce soil spilling in back of the blade, making soil moving more efficient.



- Automatic travel speed change and travel switch **New**

The travel speed selector switch installed on the blade control lever allows the operator to engage high speed travel. Once engaged, the travel speed automatically shift up or down within the selected speed range.



Travel switch

### Improved workability at various sites

- Better hydraulic flow to attachments **New**  
Even with attachments requiring large amounts of hydraulic flow, operation can be smooth and easy.

#### Hydraulic flow to the attachment

**12% UP**

Compared to the PC78UU-10  
The data for hydraulic flow to the attachment is based on in-house test results.

- Automated attachment conversion using monitor **New**

Equipped with universal piping for attachments such as breakers or crushers, conversion to low-pressure mode requires only a push of the breaker mode switch on the monitor.



### LED lamps **New**

LED lamps are equipped on the boom. The visibility under low light environment is improved, and work at night with ease.

(LED on cab is optional)





## Safety features

### Ultra short swing superior in safety and narrow workability

PC78UU-11 design uses a tight tail concept for both ends. This enables the machine to rotate fast, easy and confident. There is less to worry about in tight space conditions because there is little protrusion from either the tail end of the front end.

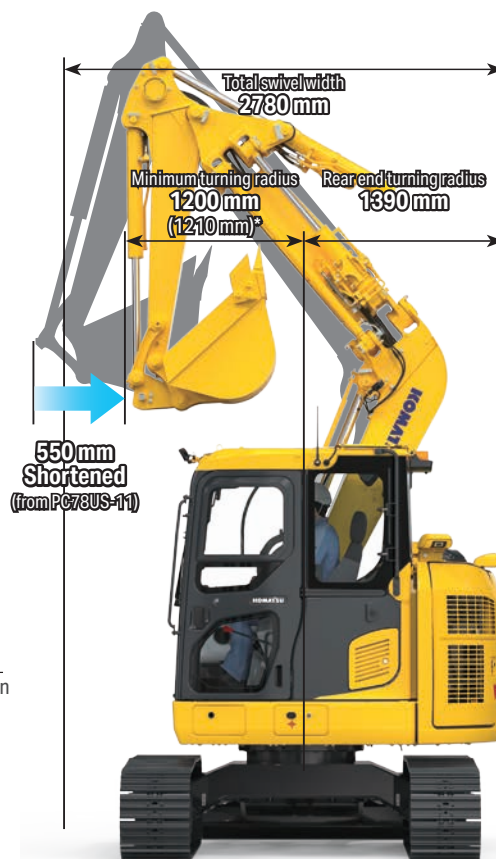
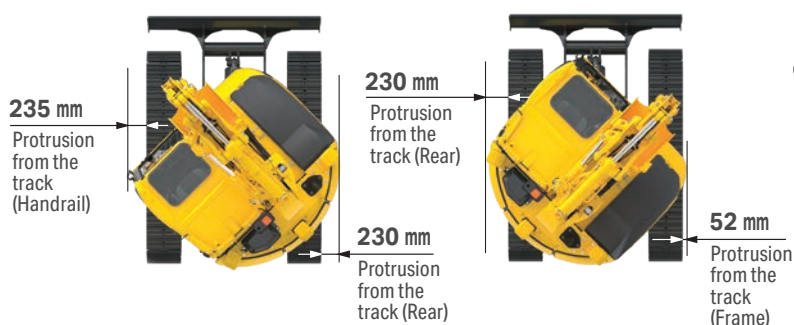

\*When interference prevention device is activated

### Lock lever auto lock function

If the work equipment lever is not in the neutral position when the hydraulic lock lever is released, the equipment is automatically stopped. The auto stop state is shown on the monitor screen.

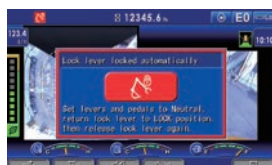

### ROPS cab (ISO 12117-2)

The machine is equipped with a ROPS cab that conforms to ISO 12117-2 for excavators as standard equipment. The ROPS cab has high shock absorption performance, featuring excellent durability and impact strength. It also satisfies the requirements of ISO OPG top guard level 1 for falling objects. Combined with the retractable seat belt.



### Safety equipment

Engine shutdown secondary switch

Engine stop switch added for abnormal use.



Seat belt caution indicator

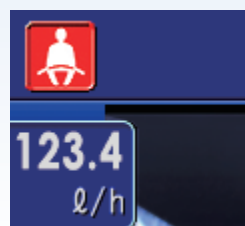

Lock lever

Seat belt retractable

Emergency escape hammer

Tempered & tinted glass

Large reflector

Travel alarm

Thermal and fan guards

Large step

Oil spray prevention cover

# ICT

## Machine monitor with evolutionary interface

The monitor screen features a high quality, high resolution LCD panel. Switches are simple and easy-to-use. Function switches make multi-functional operations easy. The high visibility screen has been re-designed so the required information is easier to see and understand, without loss of conventional operability. The main screen can display the surroundings clearly using standard KomVision. Main screen displays of images and/or data can be displayed together or separately easily by pressing F3 key.

### Indicators

- |                            |                                     |
|----------------------------|-------------------------------------|
| 1 Auto-decelerator         | 8 Clock                             |
| 2 Working mode             | 9 Eco gauge                         |
| 3 Travel speed             | 10 Engine coolant temperature gauge |
| 4 Fuel consumption gauge   | 11 Hydraulic oil temperature gauge  |
| 5 Camera display           | 12 Fuel gauge                       |
| 6 Service meter            | 13 Guidance icon                    |
| 7 Camera direction display | 14 Function switches                |

### Basic operation switches

- |                         |                 |
|-------------------------|-----------------|
| 1 Auto-decelerator      | 4 Buzzer cancel |
| 2 Working mode selector | 5 Wiper         |
| 3 Traveling selector    | 6 Window washer |



## KomVision New

The surroundings of the machine can be displayed on the monitor by using 3 cameras installed at the sides and rear of the machine. Press the switch F4 to select the image of the right, left and rear side view of the machine.

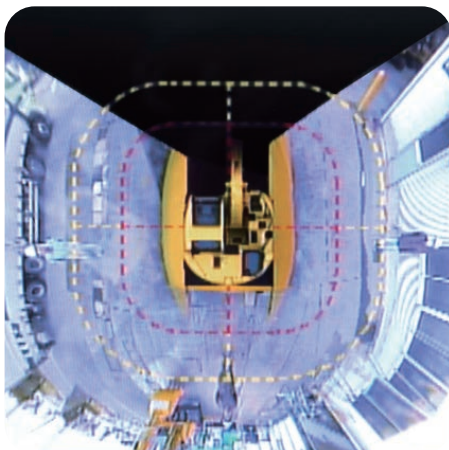

## Support efficiency improvement

- ECO guidance

While the machine is operating, ECO guidance pops up on the monitor screen to notify the operator of the status of the machine in real time.

- Avoid Excessive Engine Idling
- Use Economy Mode to Save Fuel
- Avoid Hydraulic Relief Pressure
- Reduce Engine Speed During Long Travel to Save Fuel

- ECO gauge & fuel consumption gauge

The monitor screen is provided with an ECO gauge and also a fuel consumption gauge which is displayed continuously. In addition, the operator can set any desired target value of fuel consumption (Within the range of the green display), enabling the machine to be operated with better fuel economy.

Fuel consumption gauge



ECO gauge

ECO guidance

- Operation record, fuel consumption history, and ECO guidance record

The ECO guidance menu enables the operator to check the operation record, fuel consumption history and ECO guidance record from the ECO guidance menu, using a single touch, thus enabling the total fuel consumption to be reduced.



Operation record



Fuel consumption history

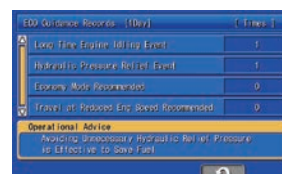

ECO guidance record

- Visual user menu

Pressing the F6 key on the main screen displays the user menu screen. The menus are grouped for each function, and use easy-to-understand icons which enable the machine to be more intuitively.

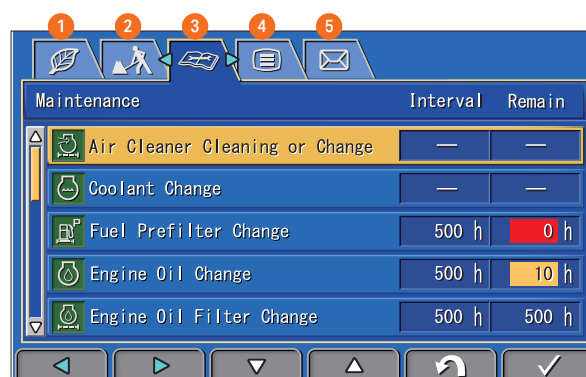

- ① Energy saving guidance
- ② Machine settings
- ③ Maintenance
- ④ Monitor setting
- ⑤ Mail check



# Comfort

## Comfortable cab and newly added equipment

A cab as wide as a cab on standard size machine is equipped on this machine even though this machine has an extra small rear turning radius.

- Low interior noise reducing operator fatigue  
A comfortable low noise cab enables longer operation with less fatigue.

### Noise level at operator ears

**71 dB (A)**

- Suspension seat **New**

The reclining seat has deep side supports for the operator. The backrest angle can be easily adjusted using a pull-up lever for the optimum operating posture.

- Multifunction audio **New**

It has functions of AM/FM radio and Bluetooth® wireless technology enabled products can be connected.



- Sliding door and round-shaped cab

The sliding door is safer than the hinged type, alongside walls, in narrow spaces, or in densely populated areas since no margin is required for hinged opening. It reduces the possibility of “dooring” people or objects, causing injury or damage. Since the cab is round-shaped, it is easy to enter or leave in narrow spaces.



## Cab standard equipment

USB port for charging **New**



Defroster  
(Conform to the ISO standard)



LED room light



Cup holder  
Ashtray



Sliding window glass (left side)  
**New**



Cigarette lighter &  
12 V x 2 power supply



Sunshade



Pull-up front window

Remote intermittent wiper with  
windshield washer

Magazine box

# KOMTRAX

# KOMTRAX

Assists customer's equipment management and contributes to fuel cost cutting

## Equipment management support

KOMTRAX terminal installed on your machine collects and sends information such as machine location, working record, machine conditions, etc. using wireless communication. You can review the KOMTRAX data remotely via the online application. KOMTRAX not only gives you the power of knowledge on your machine, but also the convenience of managing your fleet on the web.

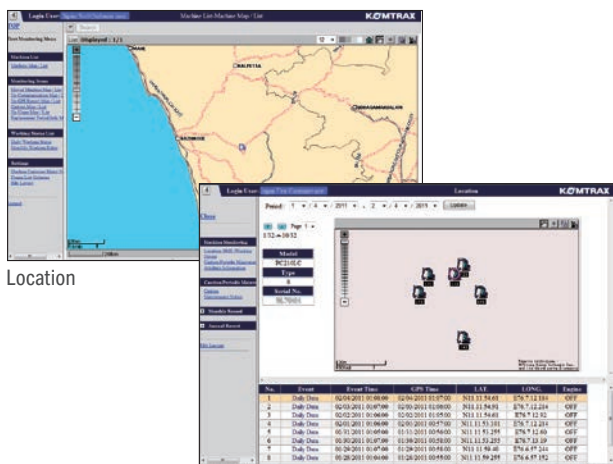

Location

Movement generated position

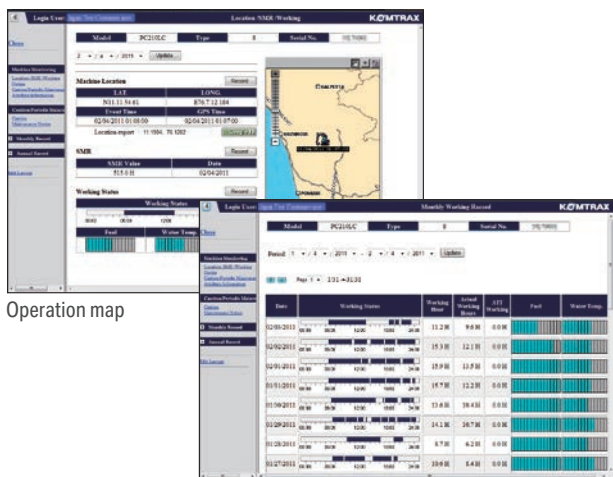

Operation map

Monthly status summary



## Energy saving operation support report

KOMTRAX can provide various useful information which includes the energy saving operation support report created based on the operating information of your machine such as fuel consumption and idle time.

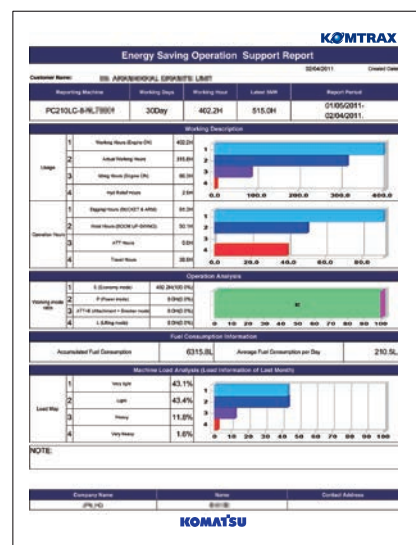

## Maintenance & robustness features

**A wealth of devices is provided throughout the machine for reducing inspection and maintenance work and also machine downtime.**

- Enlarged body cover apertures **New**

Body cover apertures are bigger for better accessibility and a larger work space for maintenance.

- Easy to clean cooling unit area **New**

Modification of body panel construction makes cleaning around the cooling unit easier, even at the site with dust and sawdust.

1. Openable air conditioner condenser, easy to clean with an air blower
2. Sawdust and dust are easily cleaned using air blown through the dust discharge cover and blow hole

- Enclosed cooling system **New**

This system not only makes cooling more efficient, but also maintenance-free until the next coolant change.





• Centralized configuration of fuel/oil filters **New**

The new layout centralizes fuel/oil filters at just the right height for easy access. This reduces the labor and stress involved in periodic inspections.



Fuel pre-filter (With water separator)      High efficiency fuel filter      Engine oil filter      Fuel drain valve

• Engine oil drain valve **New**

The new engine oil drain valve makes draining engine oil an easy one-touch operation.

• New easy to fill, fuel filler port **New**

The new front right cover has a two-step lock system, which makes it possible to fill the fuel from ground level.



• New washer tank and additional filter for breaker are accessible from ground level. **New**



Washer tank      Additional filter for breaker

• Easy to clean, new floor mat **New**

Removing the floor mat for the cleaning is easy since it is not fixed by bolts.



• High-performance air conditioner filter (Optional) **New**

A filter optimized for collecting particulate matter protects the air conditioner.



• Air conditioner compressor belt auto-tensioner **New**

For free maintenance of air conditioner compressor belt tension adjustment.

• Battery disconnect switch

A standard battery disconnect switch allows a technician to disconnect the power supply and lock out before servicing the machine.



• Long-life oil, filter

Engine oil & engine oil filter	every 500 hours
Hydraulic oil	every 5000 hours
Hydraulic oil filter	every 1000 hours



Hydraulic oil filter

• "Maintenance time caution lamp" display

When the remaining time to maintenance becomes less than 30 hours\*, the maintenance time monitor appears. Pressing the F6 key switches the monitor to the maintenance screen.

\*:The setting can be changed within the range between 10 and 200 hours.

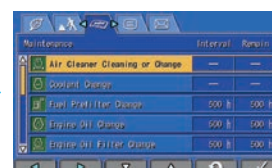
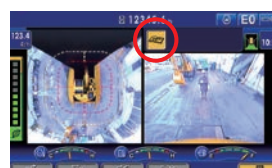

Maintenance screen

• Maintenance-free battery **New**

The high-performance battery eliminates the inconvenience of having to top up the battery fluid.

# Specifications

## Engine

Model	Komatsu SAA3D95E-1	
Type	Water-cooled, 4-cycle direct injection	
Aspiration	Variable flow turbocharged, aftercooled, cooled EGR	
Number of cylinders	3	
Bore	95 mm	
Stroke	115 mm	
Piston displacement	2.45 L	
Horsepower		
SAE J1995	Gross 50.7 kW (68.0 HP) / 1900 min <sup>-1</sup>	
ISO 14396	50.7 kW (68.0 HP) / 1900 min <sup>-1</sup>	
ISO 9249 / SAE J1349	Net 50.6 kW (67.8 HP) / 1850 min <sup>-1</sup>	
Fan at maximum speed	Net 48.4 kW (64.8 HP) / 1850 min <sup>-1</sup>	
Fan drive method for radiator cooling	Mechanical	
Governor	All-speed control, electronic	
U.S. EPA Tier 4 Final emissions certified.		

## Hydraulics

Type	HydrauMind (Hydraulic Mechanical Intelligence New Design) system, closed-center system with load sensing valves and pressure compensated valves	
Number of selectable working modes	6	
Main pump		
Pumps for	Boom, arm, bucket, swing and travel circuits	
Type	Variable displacement, axial piston	
Maximum flow	168 L/min	
Pumps for	Blade	
Type	Fixed displacement gear	
Maximum flow	63 L/min	
Supply for control circuit	Self-reducing valve	
Hydraulic motors		
Travel	2 x axial piston motors with parking brake	
Swing	1 x axial piston motor with swing holding brake	
Relief valve setting		
Implement circuits	26.5 MPa 270 kgf/cm <sup>2</sup>	
Travel circuit	27.0 MPa 275 kgf/cm <sup>2</sup>	
Swing circuit	20.6 MPa 210 kgf/cm <sup>2</sup>	
Pilot circuit	3.2 MPa 33 kgf/cm <sup>2</sup>	
Blade circuit	21.1 MPa 215 kgf/cm <sup>2</sup>	
Hydraulic cylinders		
(Number of cylinders – bore x stroke x rod diameter)		
Boom	1–120 mm x 1015 mm x 70 mm	
Arm	1–110 mm x 715 mm x 65 mm	
Bucket	1–90 mm x 710 mm x 55 mm	
Boom offset	1–110 mm x 350 mm x 55 mm	
Blade	1–130 mm x 130 mm x 65 mm	

## Drives and brakes

Steering control	Two levers with pedals
Drive method	Hydrostatic
Maximum drawbar pull	68.2 kN 6950 kgf
Gradeability	70%, 35°
Maximum travel speed (Auto-shift)	
High	5.0 km/h
Low	2.7 km/h
Service brake	Hydraulic lock
Parking brake	Mechanical disc brake

## Swing system

Drive method	Hydrostatic
Swing reduction	Planetary gear
Swing circle lubrication	Grease-bathed
Service brake	Hydraulic lock
Holding brake/Swing lock	Mechanical disc brake
Swing speed	10 min <sup>-1</sup>

## Undercarriage

Center frame	X-frame
Track frame	Box-section
Seal of track	Sealed track
Track adjuster	Hydraulic
Number of shoes (each side)	39
Number of carrier rollers	1 each side
Number of track rollers (each side)	5

## Coolant and lubricant capacity (refill)

Fuel tank	125 L
Coolant	16 L
Engine	10.5 L
Final drive, each side	1.1 L
Swing drive	2.0 L
Hydraulic tank	56 L

## Operating weight (approximate)

Operating weight including 3750 mm offset boom, 1720 mm arm, heaped 0.28 m<sup>3</sup> bucket, rated capacity of lubricants, coolant, full fuel tank, operator, and standard equipment.

With Blade		
Shoes	Operating Weight	Ground Pressure
450 mm Triple grouser	8550 kg	37.4 kPa 0.38 kgf/cm <sup>2</sup>
450 mm Road Liner	8690 kg	37.7 kPa 0.38 kgf/cm <sup>2</sup>

## Dimensions

Boom Length	3750 mm
Arm Length	1720 mm
A Overall length	6070 mm
B Overall height (to top of boom) *	2315 mm
C Overall width	2330 mm
D Overall height (to top of cab) *	2710 mm
E Ground clearance, counterweight	735 mm
F Ground clearance (minimum)	360 mm
G Tail swing radius	1390 mm
H Track length on ground	2235 mm
I Track length	2840 mm
J Track gauge	1870 mm
K Width of crawler	2320 mm
L Shoe width	450 mm
M Grouser height	20 mm
N Machine height to top of engine cover	1925 mm
O Machine upper width	2330 mm
P Distance, swing center to rear end	1925 mm

\*Including grouser height

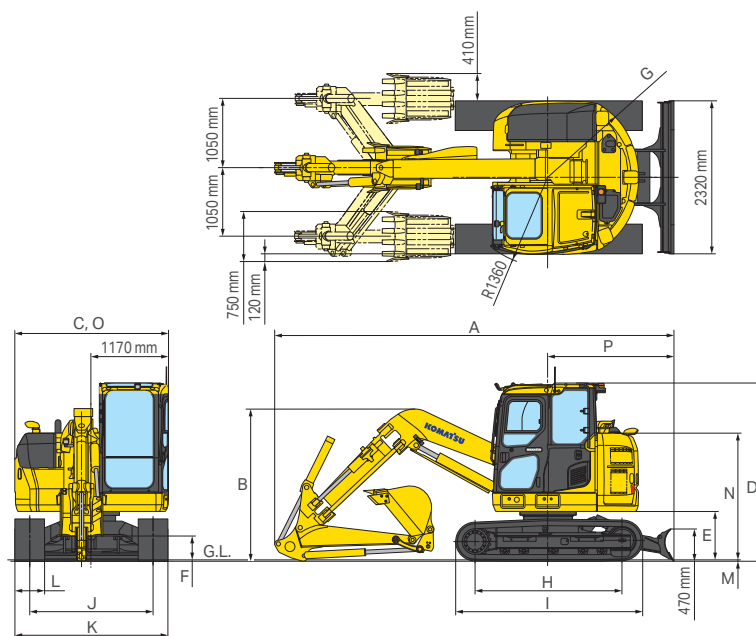

## Working range

Boom Length	3750 mm
Arm Length	1720 mm
A Maximum digging height	7330 mm
B Maximum dumping height	5260 mm
C Maximum digging depth	4230 mm
D Maximum vertical wall digging depth	3190 mm
E Maximum digging depth of cut for 2440 mm level	3795 mm
F Maximum digging reach	6400 mm
G Maximum digging reach at ground	6240 mm
H Minimum digging reach at ground	1565 mm
I Minimum swing radius	1210 mm *1 1200 mm *2
J Maximum height of minimum swing radius	5460 mm 5420 mm *3

\*1 When interference prevention cab, minimum swing radius of work equipment.

\*2 When offset 0, minimum swing radius work equipment.

\*3 When interference prevention cab

ISO 6015 Rating	Bucket digging force	61.3 kN 6250 kgf
	Arm crowd force	38.8 kN 3960 kgf

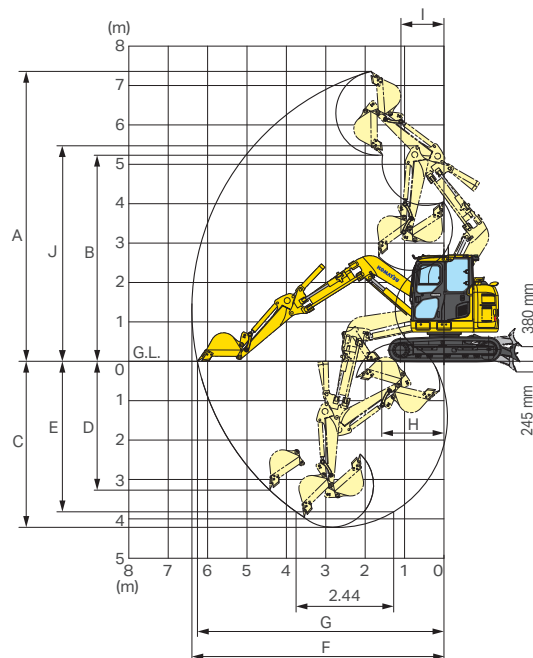



# PC78UU-11

## Lifting capacity with lifting mode

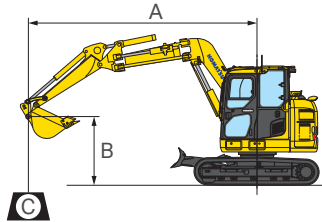

- A: Reach from swing center
- B: Bucket hook height
- C: Lifting capacity
- Cf: Rating over front
- Cs: Rating over side
- ⊗: Rating at maximum reach

Conditions :  
• 3750 mm offset boom

PC78UU-11 Arm : 1720 mm Bucket : 0.28 m <sup>3</sup> heaped Shoe width : 450 mm Triple grouser Blade off ground													
B	A	⊗ Maximum		5.5 m		5.0 m		4.5 m		4.0 m		3.5 m	
		Cf	Cs	Cf	Cs	Cf	Cs	Cf	Cs	Cf	Cs	Cf	Cs
6.0 m		*1840 kg	*1840 kg										
5.5 m		*1660 kg	*1660 kg										
5.0 m		*1580 kg	*1580 kg									*2310 kg	2280 kg
4.5 m		*1540 kg	1460 kg							2130 kg	1760 kg	*2290 kg	2280 kg
4.0 m		1520 kg	1250 kg					1670 kg	1390 kg	2110 kg	1750 kg	*2350 kg	2250 kg
3.5 m		1350 kg	1110 kg			1330 kg	1100 kg	1660 kg	1370 kg	2080 kg	1720 kg	*2470 kg	2190 kg
3.0 m		1230 kg	1000 kg			1320 kg	1080 kg	1620 kg	1340 kg	2020 kg	1660 kg	2580 kg	2110 kg
2.5 m		1140 kg	930 kg			1290 kg	1060 kg	1580 kg	1290 kg	1950 kg	1600 kg	2480 kg	2020 kg
2.0 m		1080 kg	880 kg	1040 kg	840 kg	1260 kg	1020 kg	1520 kg	1240 kg	1880 kg	1530 kg	2380 kg	1930 kg
1.5 m		1040 kg	840 kg	1020 kg	820 kg	1220 kg	990 kg	1470 kg	1190 kg	1810 kg	1470 kg	2280 kg	1830 kg
1.0 m		1020 kg	820 kg	1000 kg	800 kg	1190 kg	960 kg	1430 kg	1150 kg	1750 kg	1410 kg	2180 kg	1750 kg
0.5 m		1020 kg	820 kg	980 kg	780 kg	1160 kg	930 kg	1390 kg	1120 kg	1690 kg	1350 kg	2100 kg	1670 kg
0.0 m		1040 kg	830 kg			1130 kg	910 kg	1350 kg	1080 kg	1640 kg	1310 kg	2050 kg	1620 kg
-0.5 m		1070 kg	860 kg	960 kg	770 kg	1120 kg	890 kg	1330 kg	1060 kg	1610 kg	1280 kg	2010 kg	1580 kg
-1.0 m		1140 kg	910 kg			1110 kg	890 kg	1320 kg	1050 kg	1590 kg	1260 kg	1980 kg	1560 kg
-1.5 m		1250 kg	1000 kg					1320 kg	1050 kg	1590 kg	1260 kg	1980 kg	1560 kg
-2.0 m		1430 kg	1140 kg					1340 kg	1070 kg	1600 kg	1270 kg	2000 kg	1570 kg
-2.5 m		1730 kg	1370 kg							*1590 kg	1310 kg	*2020 kg	1610 kg
-3.0 m		*1550 kg	*1550 kg										

B	A	3.0 m		2.5 m		2.0 m		1.5 m		1.0 m	
		Cf	Cs	Cf	Cs	Cf	Cs	Cf	Cs	Cf	Cs
6.0 m				*2210 kg	*2210 kg						
5.5 m		*2480 kg	*2480 kg	*2590 kg	*2590 kg						
5.0 m		*2400 kg	*2400 kg	*2510 kg	*2510 kg						
4.5 m		*2410 kg	*2410 kg	*2550 kg	*2550 kg						
4.0 m		*2510 kg	*2510 kg	*2650 kg	*2650 kg						
3.5 m		*2700 kg	*2700 kg	*3000 kg	*3000 kg	*2890 kg	*2890 kg				
3.0 m		*2960 kg	2770 kg	*3440 kg	*3440 kg	*4210 kg	*4210 kg	*5200 kg	*5200 kg	*7600 kg	*7600 kg
2.5 m		3250 kg	2640 kg	*3980 kg	3640 kg	*4820 kg	*4820 kg				
2.0 m		3130 kg	2490 kg	4280 kg	3380 kg						
1.5 m		2960 kg	2350 kg	4080 kg	3130 kg						
1.0 m		2820 kg	2220 kg	3860 kg	2930 kg						
0.5 m		2710 kg	2120 kg	*3690 kg	2820 kg						
0.0 m		2640 kg	2050 kg	*3650 kg	2750 kg						
-0.5 m		2600 kg	2020 kg	3620 kg	2730 kg	*2690 kg	*2690 kg				
-1.0 m		2580 kg	2000 kg	3630 kg	2730 kg	*3500 kg	*3500 kg	*2650 kg	*2650 kg		
-1.5 m		2590 kg	2000 kg	*3630 kg	2760 kg	*4380 kg	*4190 kg	*3470 kg	*3470 kg	*3070 kg	*3070 kg
-2.0 m		2610 kg	2030 kg	*3440 kg	2790 kg	*3850 kg	*3850 kg	*4110 kg	*4110 kg	*3820 kg	*3820 kg
-2.5 m		*2530 kg	2070 kg	*2870 kg	*2810 kg	*3170 kg	*3170 kg	*3330 kg	*3330 kg		
-3.0 m		*1850 kg	*1850 kg	*2130 kg	*2130 kg	*2310 kg	*2310 kg				

\* Load is limited by hydraulic capacity rather than tipping. Ratings are based on SAE J1097. Rated loads do not exceed 87% of hydraulic lift capacity or 75% of tipping load.

## Standard and optional equipment

### Engine

Air cleaner, double element with auto dust evacuator	●
Cooling fan clutch system, suction type	●
Cooling system with expansion tank	●
Engine, Komatsu SAA3D95E-1	●
Engine overheat prevention system	●
Engine oil-pan with drain cock	●

### Electrical system

Alternator, 24 V/60 A	●
Auto-decelerator	●
Batteries, 2 x 12 V/60 Ah (Maintenance free batteries)	●
Battery disconnect switch	●
Electric horn	●
Starting motor 24 V/4.5 kW	●

### Hydraulic system

Hydraulic control unit - 1 additional actuator	●
------------------------------------------------	---

### Guards and covers

Fan guard structure	●
Pump/engine partition cover	●
Cab guard, bolt-on top guard, OPG level 2 (ISO 10262)	○
Cab guard, lower front window guard	○

### Undercarriage

Shoe, 450 mm road liner	●
Shoe, 450 mm triple grouser	○

### Operator environment

12 V x 2 power supply	●
2 way multi-control valve	●
Attachment flow switching by monitor	●
Auto air conditioner	●
Auto idle stop function	●
Cab includes: antenna, multifunction audio, floor mat, intermittent front windshield wiper and washer, pull-up front window, removable lower windshield, sliding window glass (left side)	●
Large high resolution LCD monitor	●
LED working light on boom	●
Lock lever	●
Lock lever auto lock function	●
Operator identification function	●
OPG top guard level 1 (ISO 10262)	●
ROPS cab (ISO 12117-2)	●
Seat belt, 78 mm	●
Suspension seat	●
Swing holding brake	●
Travel alarm	●
Travel Hi/Lo switchable with blade lever switch	●
LED working light on cab	○
Pollen type air-conditioner filter	○

### Work equipment

1720 mm arm assembly with piping	●
3750 mm offset boom assembly with piping	●
Blade (Welded cutting edge type)	●

### Other equipment

Equipment management monitoring system	●
Heavy counterweight	●
KOMTRAX	●
Rear reflector	●
KomVision	●
Beacon lamp (Cab top)	○

Further equipment on request

- Standard equipment
- Optional equipment

This specification sheet may contain attachments and optional equipment that are not available in your area. Please consult your local Komatsu distributor for those items you may require.

Materials and specifications are subject to change without notice.

- The Bluetooth® word mark and logos are registered trademarks owned by Bluetooth SIG, Inc. and any use of such marks by KOMATSU Group is under license. Other trademarks and trade names are those of their respective owners.
- Up to 20% blended biodiesel fuel and paraffine fuel can be used. Please consult your Komatsu distributor for detail.
- Materials and specifications are subject to change without notice.
- **KOMATSU** is a trademark of Komatsu Ltd. Japan.

---

Your Komatsu partner:

**KOMATSU**

<https://www.komatsu.jp/en>